

# Hello

---

**Congratulations on your new purchase of an oCOSMO HDTV!!** We thank you for your support. To ensure safety and many years of trouble free operation of your HDTV, please read this manual carefully before making any adjustments. **Please also write down your TV p/n number and s/n number (located on the back of the TV) on a piece of paper in case you need to reference it.** Please keep the paper and this manual in a safe place for future references. We hope you enjoy your new HDTV.

## Features

- Energy saving LED backlit 1080P FHD display panel
- MHL enabled HDMI® port (only under HDMI 2) for your MHL enabled device (tablet or cellphone)
- Roku™ ready TV (Supports Roku streaming stick under HDMI 2 / MHL port)
- USB connection to display pictures and play music files

**For technical assistance**, please call our toll-free telephone number (855) 662-6766 and select option 3. You can also email our technical support group at [OCOSMOTS@OCOSMO.COM](mailto:OCOSMOTS@OCOSMO.COM) or chat with us online at [OCOSMO.com](http://OCOSMO.com) under the SUPPORT tab.

**For all other general inquiries**, please call our toll-free telephone number (855) 662-6766 and select option 4. You can also email our customer service group at [OCOSMOCS@OCOSMO.COM](mailto:OCOSMOCS@OCOSMO.COM) or chat with us online at [OCOSMO.com](http://OCOSMO.com) under the SUPPORT tab.

We recommend you register your oCOSMO HDTV at our online website <http://www.oCOSMO.com/>.

# Important Information

**WARNING:** TO REDUCE THE RISK OF FIRE OR ELECTRIC SHOCK, DO NOT EXPOSE THIS PRODUCT TO RAIN OR MOISTURE.

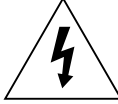
	<b>CAUTION</b> RISK OF ELECTRICAL SHOCK DO NOT OPEN	
CAUTION: TO REDUCE THE RISK OF ELECTRIC SHOCK, DO NOT REMOVE COVER (OR BACK). NO USER-SERVICABLE PARTS INSIDE. REFER SERVICING TO QUALIFIED PERSONNEL.		

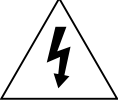
	<b>AVIS</b> RISQUE DE CHOC ÉLECTRIQUE NE PAS OUVRIR	
ATTENTION : POUR RÉDUIRE LE RISQUE DE DÉCHARGE ÉLECTRIQUE, NE RETIREZ PAS LE COUVERCLE (OU L'ARRIÈRE). IL NE SE TROUVE À L'INTÉRIEUR AUCUNE PIÈCE POUVANT ÊTRE RÉPARÉE PAR L'USAGER. S'ADRESSER À UN RÉPARATEUR COMPÉTENT.		



The lightning flash with arrowhead symbol within an equilateral triangle alerts the user to the presence of uninsulated, dangerous voltage within the system enclosure that may be of sufficient magnitude to constitute a risk of electric shock.



The exclamation point within an equilateral triangle alerts the user to the presence of important operating and maintenance instructions in this user's guide.

**CAUTION:** TO PREVENT ELECTRIC SHOCK, MATCH WIDE BLADE OF PLUG TO WIDE SLOT, FULLY INSERT.

CAUTION: DO NOT PLACE THIS PRODUCT ON AN UNSTABLE CART, STAND, TRIPOD, BRACKET, OR TABLE. THE PRODUCT MAY FALL CAUSING SERIOUS PERSONAL INJURY AND SERIOUS DAMAGE TO THE PRODUCT. USE ONLY WITH A CART, STAND, TRIPOD, BRACKET, OR TABLE RECOMMENDED BY THE MANUFACTURER OR SOLD WITH THE PRODUCT. FOLLOW THE MANUFACTURER'S INSTRUCTIONS WHEN INSTALLING THE PRODUCT AND USE MOUNTING ACCESSORIES



# Important Information

---

RECOMMENDED BY THE MANUFACTURER. A PRODUCT AND CART COMBINATION SHOULD BE MOVED WITH CARE. QUICK STOPS, EXCESSIVE FORCE, AND UNEVEN SURFACES MAY CAUSE THE PRODUCT AND CART COMBINATION TO OVERTURN.

**WARNING:** FCC Regulations state that any unauthorized changes or modifications to this equipment not expressly approved by the manufacturer could void the user's authority to operate this equipment.

**CAUTION:**

This product satisfies FCC regulations when shielded cables and connectors are used to connect the unit to other equipment. To prevent electromagnetic interference with electric appliances such as radios and televisions, use shielded cables and connectors for connections.

\*Note to CATV system installers: This remainder is provided to call the CATV system installer's attention to Article 820-40 of the National Electrical Code that provides guidelines for proper grounding and, in particular specifies that the cable ground shall be connected to the grounding system of the building, as close to the point of cable entry as practical.\*

This product utilizes tin-lead solder. Disposal of these materials may be regulated due to environmental considerations. For disposal or recycling information please contact your local authorities or the online website <http://earth911.com/>.

# Safety Instructions

---

Electricity is used to perform many useful functions, but it can also cause personal injuries and property damage if improperly handled. This product has been engineered and manufactured with the highest priority on safety. However, improper use can result in electric shock and / or fire. In order to prevent potential danger, please observe the following instructions when installing, operating and cleaning the product. To ensure your safety and prolong the service life of your LED backlit Liquid Crystal Television, please read the following precautions carefully before using the product.

1. Read these instructions.
2. Keep these instructions.
3. Heed all warnings.
4. Follow all instructions.
5. Do not use this apparatus near water.
6. Clean only with dry cloth.
7. Do not block any ventilation openings. Install in accordance with the manufacturer's instructions.
8. Do not install near any heat sources such as radiators, heat registers, stoves, or other apparatus (including amplifiers) that produce heat.
9. Do not defeat the safety purpose of the polarized or grounding-type plug. A polarized plug has two blades

with one wider than the other. A grounding type plug has two blades and a third grounding prong. The wide blade and the third prong are provided for your safety. If the provided plug does not fit into your outlet, consult an electrician for replacement of the obsolete outlet.

10. Protect the power cord from being walked on or pinched particularly at the plugs, convenience receptacles, and the point where they exit from the apparatus.
11. Only use attachments/accessories specified by the manufacturer.
12. Use only with the cart, stand, tripod, bracket, or table specified by the manufacturer, or sold with the apparatus. When a cart is used, use caution when moving the cart/apparatus combination to avoid injury from tip-over.
13. Unplug this apparatus during lightening storms or when unused for long periods of time.
14. Refer all servicing to qualified service personnel. Servicing is required when the apparatus has been damaged in any way, such as power-supply cord or plug is damaged, liquid has been spilled or objects have fallen into the apparatus, the apparatus has been exposed to rain or moisture, does not operate normally, or has been dropped.

# Safety Instructions

---

This product is designed and manufactured to operate within defined design limits, and misuse may result in electric shock or fire. To prevent the product from being damaged, the following rules should be observed for the installation, use and maintenance of the product. Read the following safety instructions before operating the display. Keep these instructions in a safe place for future reference.

- To avoid the risk of electric shock or component damage, switch off the power before connecting other components to the TV.
- Unplug the power cord before cleaning the TV. Please use a micro-fiber cleaning cloth for cleaning the bezel of the TV only. Do not use a liquid or a spray cleaner for cleaning the product. Do not use abrasive cleaners.
- Always use the accessories recommended by the manufacturer to ensure compatibility.
- When moving the TV from an area of low temperature to an area of high temperature, condensation may form on the housing. Do not turn on the TV immediately after this to avoid causing fire, electric shock or component damage.
- Do not place the TV on an unstable cart, stand, or table. If the TV falls, it can injure a person and cause serious damage to the appliance. Use only a cart or stand recommended by the manufacturer or sold with the TV.
- Any heat source should maintain a distance of at least 5 feet away from the TV, i.e. radiator, heater, oven, amplifier etc. Do not install the product too close to anything that produces smoke or moisture. Operating the product close to smoke or moisture may cause fire or electric shock
- Slots and openings in the back and bottom of the cabinet are provided for ventilation. To ensure reliable operation of the TV and to protect it from overheating, be sure these openings are not blocked or covered. Do not place the TV in a bookcase or cabinet unless proper ventilation is provided.
- Never push any object into the ventilation slots of the TV. Do not place any objects on the top of the Product. It could short circuit parts causing a fire or electric shock. Never spill liquids on the TV.
- Do not use the TV in a portrait format (by rotating 90 degrees) under high temperature environment (25°C or higher), since this would retard heat dissipation and would eventually damage the TV.
- The TV should be operated only from the type of power source indicated on the label. If you are not sure of the type of power supplied to your home, consult your dealer or local power company.
- The power cable must be replaced when using different voltage from that specified in the User Manual. For more information, contact your dealer.

# Safety Instructions

- The TV is equipped with a three-pronged grounded plug, a plug with a third (grounding) pin. This plug will fit only into a grounded power outlet as a safety feature. If your outlet does not accommodate the three-wire plug, have an electrician install the correct outlet, or use an adapter to ground the appliance safely. Do not defeat the safety purpose of the grounded plug.
- Do not overload power strips and extension cords. Overloading can result in fire or electric shock.
- The wall socket should be installed near the equipment and should be easily accessible.
- Only the marked power source can be used for the product. Any power source other than the specified one may cause fire or electric shock.
- Do not touch the power cord during thunderstorms. To avoid electric shock, avoid handling the power cord during electrical storms.
- Unplug the unit during a lightning storm or when it will not be used for a long period of time. This will protect the TV from damage due to power surges.
- Do not attempt to repair or service the product yourself. Opening or removing the back cover may expose you to high voltages, the risk of electric shock, and other hazards. If repair is required, please contact your dealer and refer all servicing to qualified service personnel.
- Keep the product away from moisture. Do not expose this appliance to rain or moisture. If water penetrates into the product, unplug the power cord and contact your dealer. Continuous use in this case may result in fire or electric shock.
- Do not use the product if any abnormality occurs. If any smoke or odor becomes apparent, unplug the power cord and contact your dealer immediately. Do not try to repair the product yourself.
- Avoid using dropped or damaged appliances. If the product is dropped and the housing is damaged, the internal components may function abnormally. Unplug the power cord immediately and contact your dealer for repair. Continued use of the product may cause fire or electric shock.
- Do not install the product in an area with heavy dust or high humidity. Operating the product in environments with heavy dust or high humidity may cause fire or electric shock.
- Hold the power connector when removing the power cable. Pulling the power cable itself may damage the wires inside the cable and cause fire or electric shocks. When the product will not be used for an extended period of time, unplug the power connector.
- To avoid risk of electric shock, do not touch the connector with wet hands.
- Insert batteries in accordance with instructions while using the remote control. Incorrect polarities may cause damage and leakage of the batteries, operator injury and contamination the remote control.

# Safety Instructions

- If any of the following occurs please contact the dealer
  - \* The power connector fails or frays.
  - \* Liquid sprays or any object drops into the TV.
  - \* The Display is exposed to rain or other moisture.
  - \* The Display is dropped or damaged in any way.
  - \* The performance of the Display changes substantially.
- Operating environment: Temperature: 5°C ~ 35°C / 41°F - 95°F, Humidity: 10% to 90% non-condensing, Altitude: 0~10,000 ft.

## TV Antenna Connection Protection

### External Television Antenna Grounding

If an outside antenna or cable system is to be connected to the TV, make sure that the antenna or cable system is electrically grounded to provide some protection against voltage surges and static charges. Article 810 of the National Electrical Code, ANSI/NFPA 70, provides information with regard to proper grounding of the mast and supporting structure, grounding of the lead-in wire to an antenna discharge unit, size of the grounding conductors, location of antenna discharge unit, connection to grounding electrodes, and requirements of the grounding electrode.

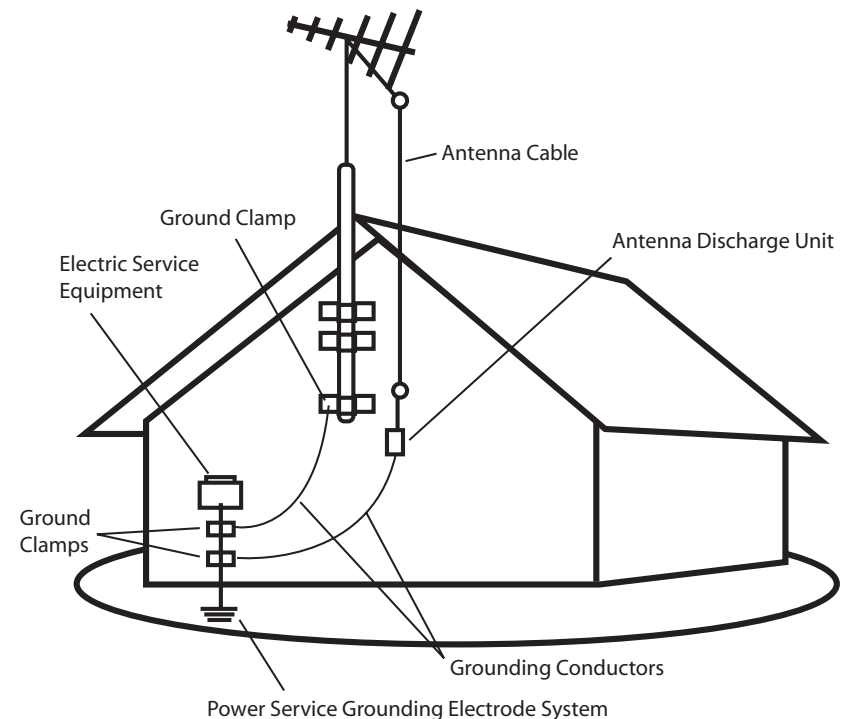

### Lightning Protection

For added protection of the TV during a lightning storm or when it is left unattended or unused for long periods of time, unplug the TV from the wall outlet and disconnect the antenna or cable system.

### Power Lines

Do not locate the antenna near overhead light or power circuits, or where it could fall into such power lines or circuits.

# Contents

Hello .....	2	Operation.....	31
Important Information .....	3	Navigating the TV Menu .....	31
Safety Instructions .....	5	Using the TV Menu .....	32
TV Antenna Connection Protection.....	8	Detailed Explanations.....	42
Contents .....	9	Maintenance .....	47
Introduction.....	10	Cleaning the TV .....	47
Opening the Package .....	10	Frequently Asked Q&As.....	47
Package Contents.....	10	Call Us If You Need Help .....	49
Installation .....	11	Specification .....	50
Before You Install .....	11	Warranty .....	51
Attaching the TV Base .....	11	Disclaimer.....	53
Preparing your TV for a Wall Mount.....	12	Compliance.....	55
Mounting Pattern Specification .....	12		
Introduction.....	13		
Front and Side Views of the TV .....	13		
Back View of the TV.....	14		
TV Connections .....	15		
oCOSMO TV Remote Control.....	16		
Installing Batteries to the Remote .....	20		
Setup .....	21		
Suggestions for Connecting your TV .....	21		
Switching Video Sources on your TV .....	31		



# Introduction

## Opening the Package

The oCOSMO TV is packaged in a carton. Any standard accessories are packed separately in another bag. The weight of the TV is approximately 19.27 lbs. Due to the size and weight of the product, it is suggested that it must be handled by a minimum of 2 or more persons. Since the glass can be easily scratched or broken, please handle the product gently. Never place the unit on a surface with the glass facing downwards unless it is on protective padding. When opening the carton, check that the product is in good condition and that all standard accessories and items are included. Save the original box and all packing materials for future shipping needs.

## Package Contents

- 1 x oCOSMO TV Display
- 1 x TV Base
- 1 x User's Manual
- 1 x Quick Start Guide
- 1 x Circular Metal Plate
- 1 x Plastic Ring
- 4 x Thick Thread Screws (A)
- 5 x Fine Thread Screws (B) [Pre-installed]
- 1 x Screw driver
- 1 x Warranty Card
- 1 x TV Remote Control (AAA Batteries included)



oCOSMO TV



Remote Control

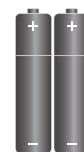

AAA  
Batteries



Circular  
Metal Plate



Screw Driver



Plastic Ring



User's Manual



Quick Start Guide



Warranty Card

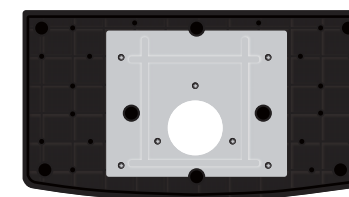

TV Base



Thick Thread Screws (A) x 4



Fine Thread Screws (B) x 5  
[Pre-installed]

# Installation

## Before You Install

Please read the user manual carefully before performing the installation. The power consumption of the display is approximately 61 watts. Please use the power cord designated for the product. When an extension cord is required, use one with the correct power rating. The cord must be grounded and the grounding feature must not be defeated. The product should be installed on a flat surface to avoid tipping. Space should be maintained between the back of the product and the wall for proper ventilation. If you would like to mount the TV onto the wall, please see the installation section of the manual for additional information. Avoid installing the product in the kitchen, bathroom or other places with high humidity dust or smoke, so as not to shorten the service life of the electronic components. Please ensure the product is installed with the screen in landscape orientation. Any 90° clockwise or counterclockwise installation may induce poor ventilation and component damage.

## Attaching the TV Base

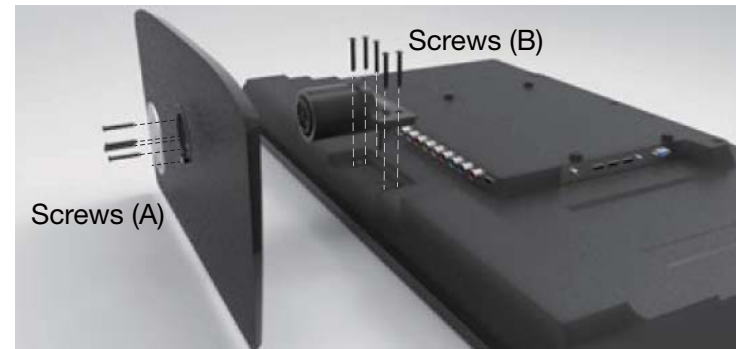

1. Find a cloth covered table. Please lay the TV flat on the table with the TV screen facing downwards.
2. Install the TV base onto the neck of the TV with the protruding plastic block on the circular hole facing downwards. Fit the included plastic ring to the hole at the bottom of the base.



# Installation

3. Fit the included metal circular plate to the bottom of the base and screw in the 4 included screws (A). Please make sure the rail on the metal plate fits the protruding plastic block on the base. Also make sure the 3 small circular holes fit the neck piece.

## Preparing your TV for a Wall Mount

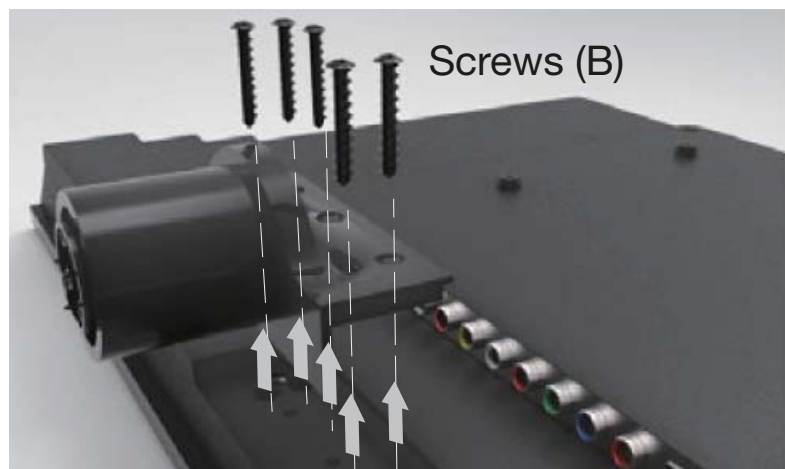

1. Find a cloth covered table. Please lay the TV flat on the table with the TV screen facing downwards.
2. Locate the neck on the back of the TV and unscrew the 5 screws (B). The neck will come off once the screws are removed.

## Mounting Pattern Specification

The TV uses **200mm horizontal by 200mm vertical** mounting specification. The screw size to mount with the TV is **M5**. The mounting holes on the TV are **12mm at the top and 6mm deep at the bottom**. Please write down your TV p/n number and s/n number (located on the back of the TV on a barcode sticker) before you mount the TV.

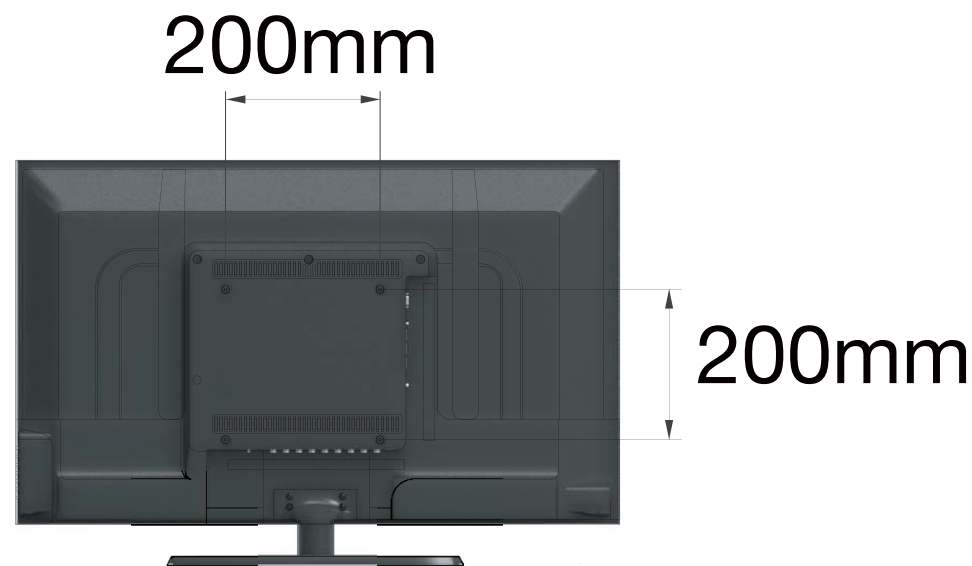

Please Note:

- Mounting screws and wall mount hardware are not included. When you are purchasing the screws be sure to add the mounting plate thickness to the screw length (12mm and 6mm respectively).

# Introduction

## Front and Side Views of the TV



LED Indicator &  
Remote Sensor

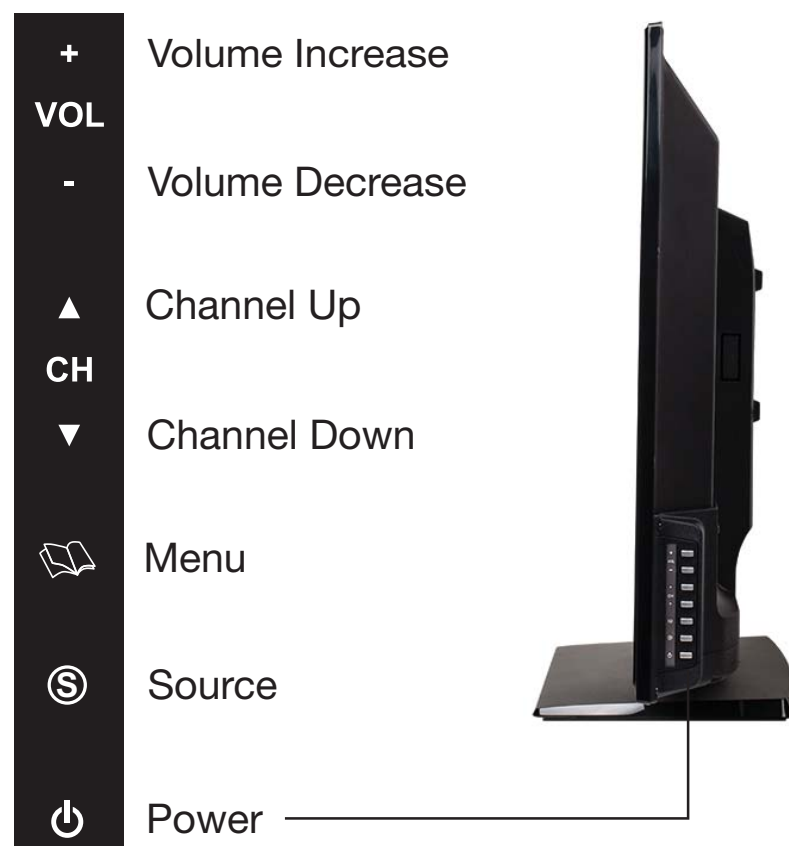

- + Volume Increase
- VOL
- Volume Decrease
- ▲ Channel Up
- CH
- ▼ Channel Down
- Menu
- Source
- Power

# Introduction

## Back View of the TV

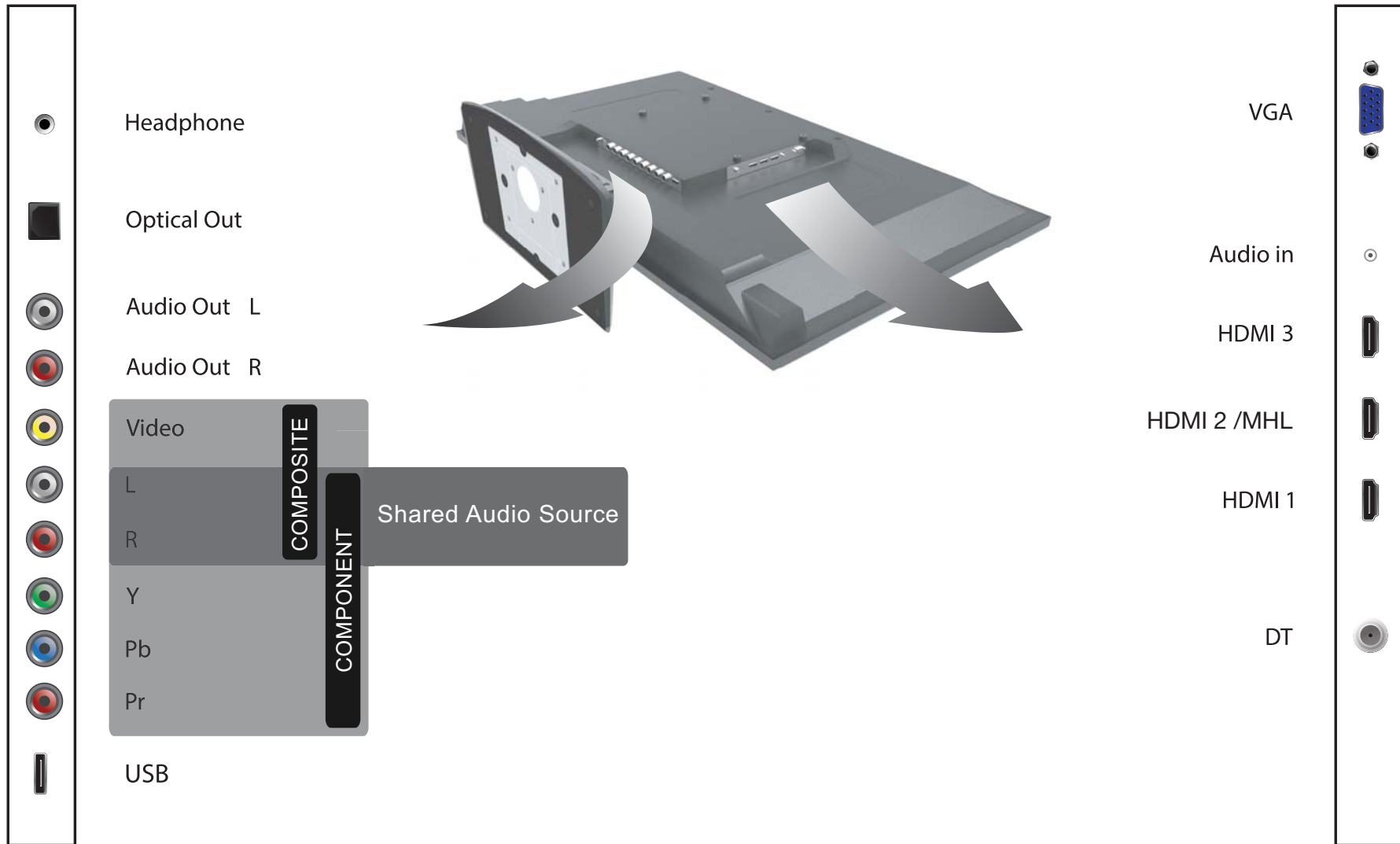

## TV Connections

The oCOSMO HDTV contains a variety of possible connections on the back of the TV. Please reference the picture on p.13 while you read through the explanations.

1. HEADPHONE – This connection is for headphones to be attached to the TV.
2. Optical Out - This connection port is used for sending out digital audio signals to digital surround sound receivers. The square (OPTICAL SPDIF OUT) connector sends out either bit-stream or PCM digital sound signal to a home theater receiver with digital coax input.
3. Analog Audio Out – This connection is for connecting to analog audio receivers.
4. Video – Video connects to devices that use composite video cables such as VCR or DVD player or Wii™. Connect the yellow for video and the red / white for audio. This port uses the same the audio jacks with YPbPr. If you use this connection, you will not be able to use YPbPr.
5. YPbPr – This connection port is for DVD players or satellite / cable set-top boxes that use component cables. From left to right, connect green, blue, and red for video, and then connect white for left channel audio, and red for right channel audio. This port uses the same audio jacks with Video. If you use this connection you will not be able to use the yellow Video connection.
6. USB – USB connects to USB flash drives for playing music and picture. The USB port is also used for updating the TV's firmware.
7. VGA - This connection port connects to a PC for video using VGA cable. Be sure to connect your audio cable to the VGA Stereo input if you want sound out of VGA video source.
8. Audio In - This connection port is for people who want to provide audio to the TV when using a PC or a DVI video device. The sources use 3.5mm mini-jack audio cable.
9. HDMI1-3 – HDMI connects to devices that use HDMI cable, such as Blu-ray or HD DVD player, or HD cable / satellite set-top box. This connection port receives pure digital audio and high definition signal through one single cable. This port also can accept a HDCP video device for video. **HDMI 2** also doubles as the MHL connection for cell phones. MHL is a protocol where the TV will display what your cell phone displays. If your cell phone supports MHL you can purchase a MHL cable from any electronic store and connect it to HDMI 2 and also your cell phone. Make sure the TV's source is changed to HDMI 2 and turn on your cell phone. You should see an image of your cell phone screen. HDMI 2 also supports ROKU™ streaming stick. Plug the ROKU stick to HDMI 2, and switch your

# Introduction

source to HDMI 2. Afterwards use the purple colored buttons to access ROKU functions.

- DT – This connection is for analog cable without the cable box or over-the-airwave antennas. The tuner is a hybrid tuner that tunes to both analog and digital channels with antenna. This connection uses coaxial RF cable. For over-the-airwave digital stations please check <http://www.antennaweb.org>. This connection **does not** support QAM function for cable companies. To use this source press the SOURCE button then select TV.

## Please Note:

- This TV **does not** have a QAM tuner built in.
- This TV features a power saving function which will turn off the TV automatically after 10 minutes of idling on a connection with no signal. This feature is present on all connection.

## oCOSMO TV Remote Control

The oCOSMO TV's remote control follows SONY® TV's universal remote code. To find the code, please contact your cable company or satellite TV company's tech support team.

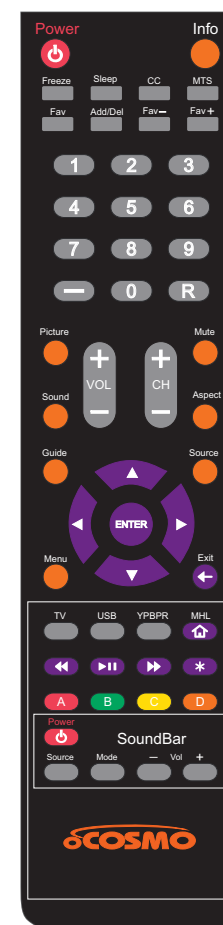

# Introduction

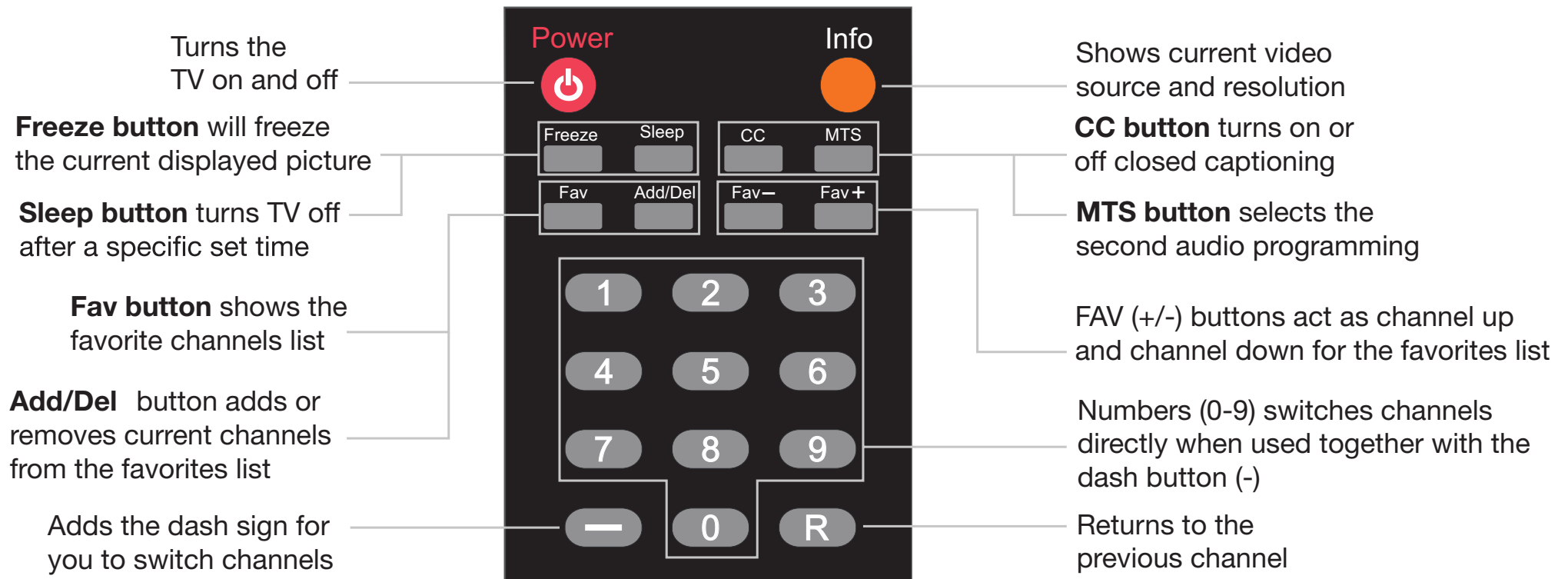



# Introduction

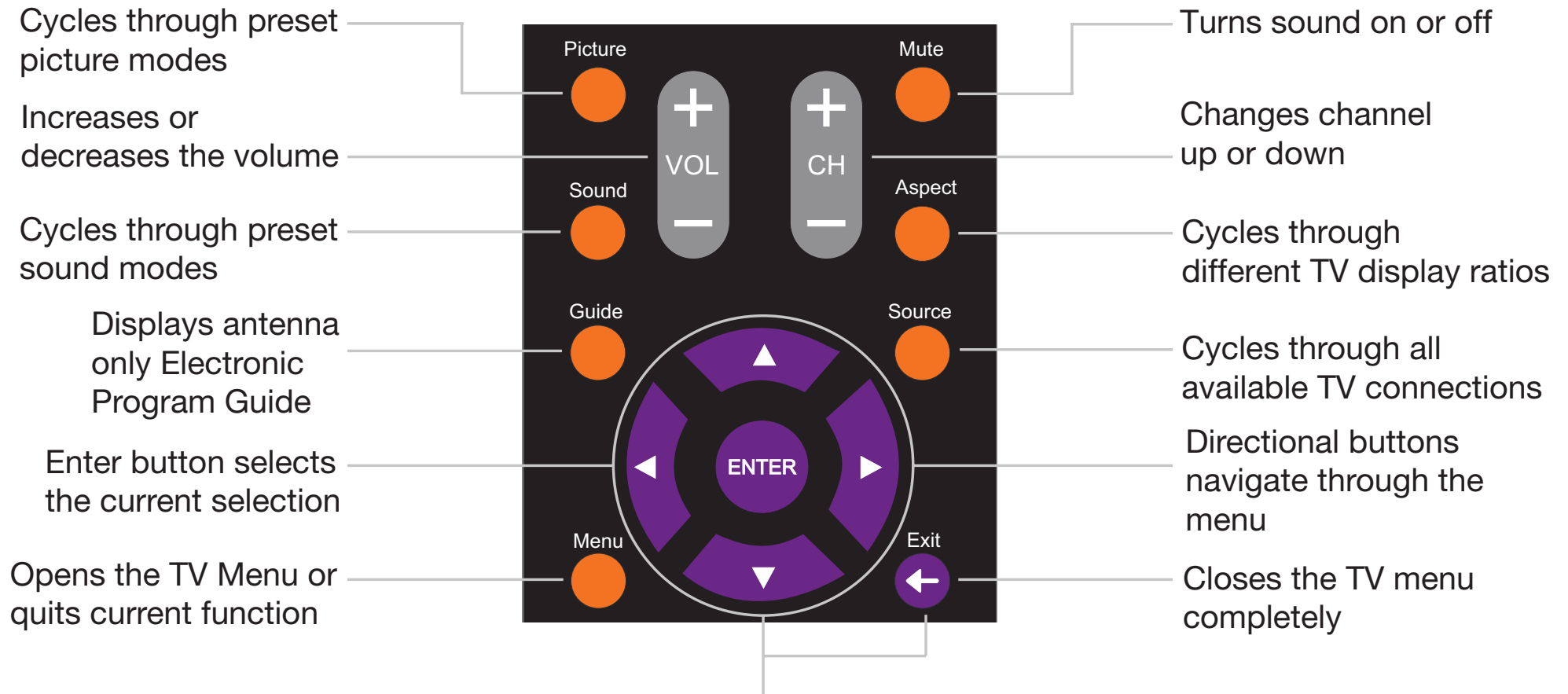

Any purple colored buttons offer similar function while TV is connected to a ROKU stick under HDMI 2

# Introduction



# Introduction

---

## Installing Batteries to the Remote

---

Please insert two AAA batteries into the remote control. Make sure that you match the (+) and (-) symbols on the batteries with the (+) and (-) symbols inside the battery compartment. Afterwards, re-attach the battery cover.



Please Note:

- Only use AAA batteries.
- Do not mix new and old batteries. This may result in cracking or leakage that may pose a fire risk or lead to personal injury.
- Inserting the batteries incorrectly may also result in crack-

ing or leakage that may pose a fire risk or lead to personal injury.

- Dispose the batteries in accordance with local laws and regulations.
- Keep the batteries away from children and pets.
- If the remote control is not used for a long time, remove the batteries.
- Keep the remote control away from moisture, sunlight, and high temperatures.
- Do not mix heavy duty and alkaline batteries.

## Suggestions for Connecting your TV

If you want to connect an antenna...

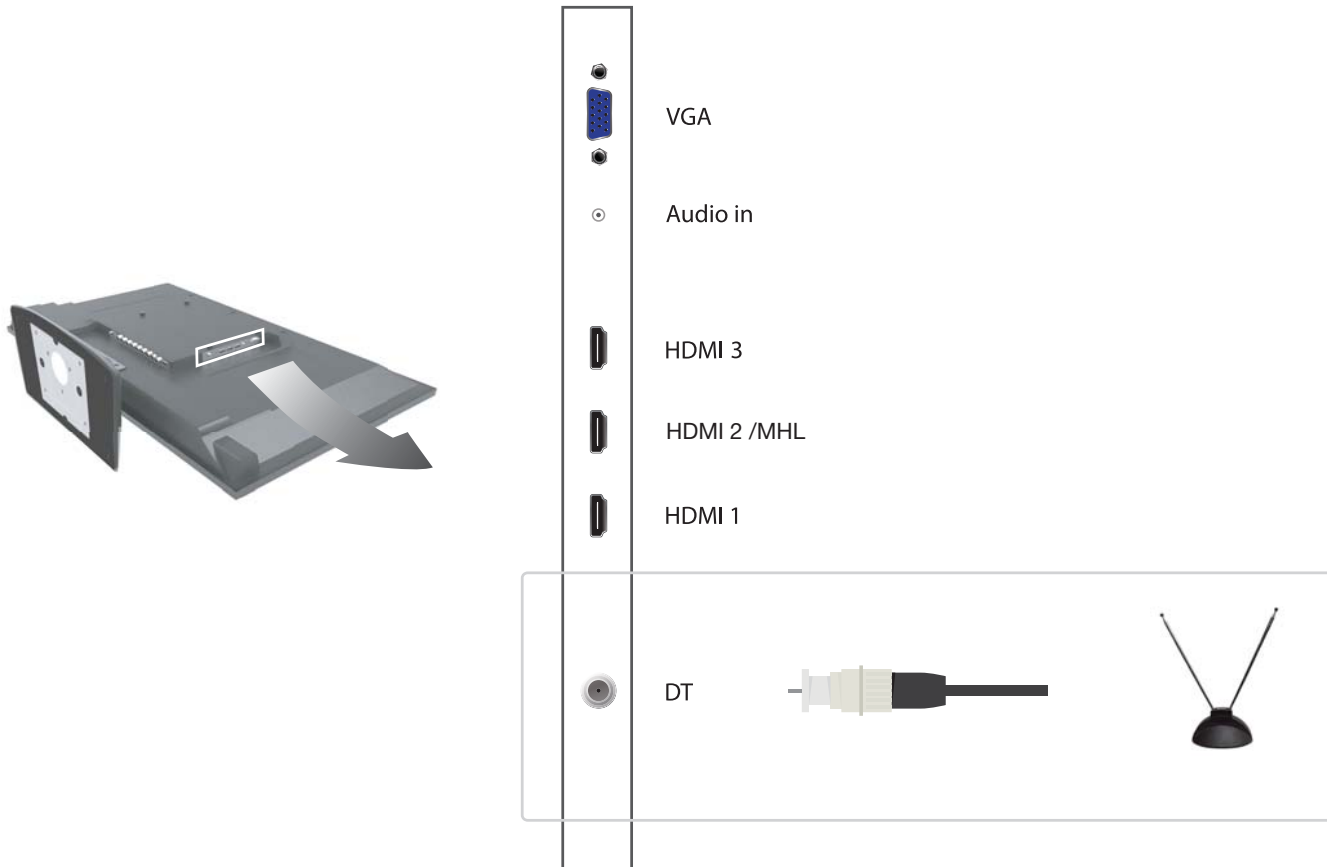

**THIS IS A HIGH DEFINITION SETUP**

Once you screw in and tighten the antenna coax cable **you have to scan for the channels before you can watch TV.**

1. Turn on the TV by pressing the POWER button on the oCOSMO TV remote.
2. Press the TV button to switch to the source TV.
3. Press the MENU button to activate the TV's menu. Use ◀ or ▶ buttons to highlight the CHANNEL option and press ENTER.
4. Inside the CHANNEL option highlight SIGNAL TYPE and make sure it is AIR. If not, use the ◀ or ▶ button to switch it to AIR.
5. Select AUTO CHANNEL SEARCH with the ▲ or ▼ button and press ENTER to use the option.
6. When the search finishes you can watch the TV.

# Setup

If you want to connect a cable box or satellite box to the DT digital tuner...

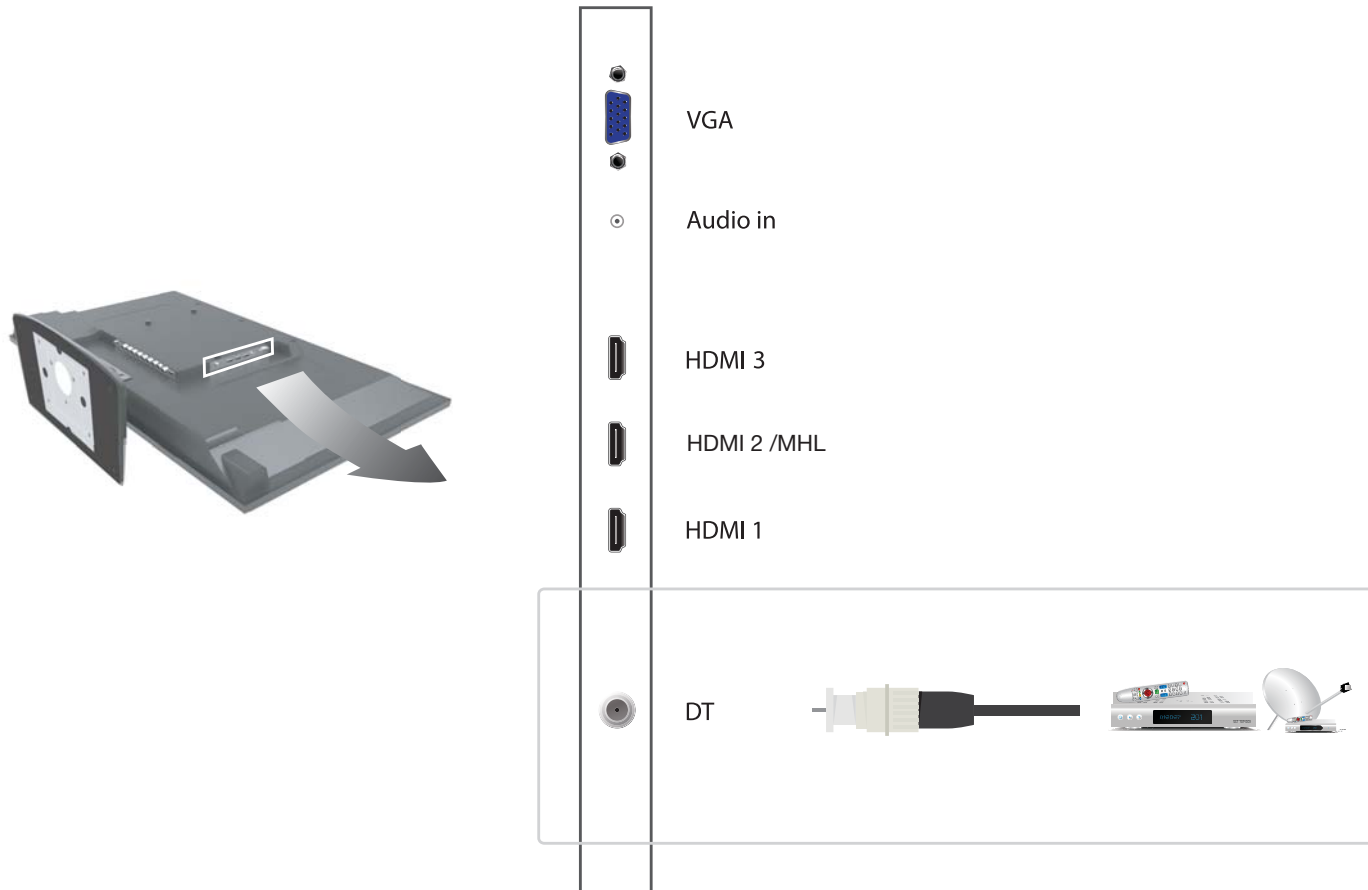

THIS IS A STANDARD DEFINITION SETUP

Once you screw in and tighten the coax cable to your cable box or satellite box, **you need to switch to the correct source and correct channel to watch TV.**

1. Press POWER on your oCOSMO remote to turn on the TV.
2. Press the TV button to switch to the source TV.
3. Press MENU activate the TV's menu and select the CHANNEL option.
4. Inside the CHANNEL option highlight SIGNAL TYPE and make sure it is AIR. If not, use the ◀ or ▶ button to switch it to CABLE.
5. Press the EXIT button to close the TV's menu.
6. Find out what channel you need to be on by calling your cable or satellite TV provider (usually it is on channel 3).
7. To switch channels press the number you want to switch to then press the ENTER button to execute the switch.
8. Turn on your cable or satellite box.
9. You can now watch the TV.
10. **Be sure to use your cable or satellite box's remote to change channels.**

Please Note:

- To setup the cable or satellite box remote control for controlling the TV, please call the cable or satellite TV company and ask them for SONY® TV's universal remote code.

If you want to connect a HD cable or satellite box using HDMI ...

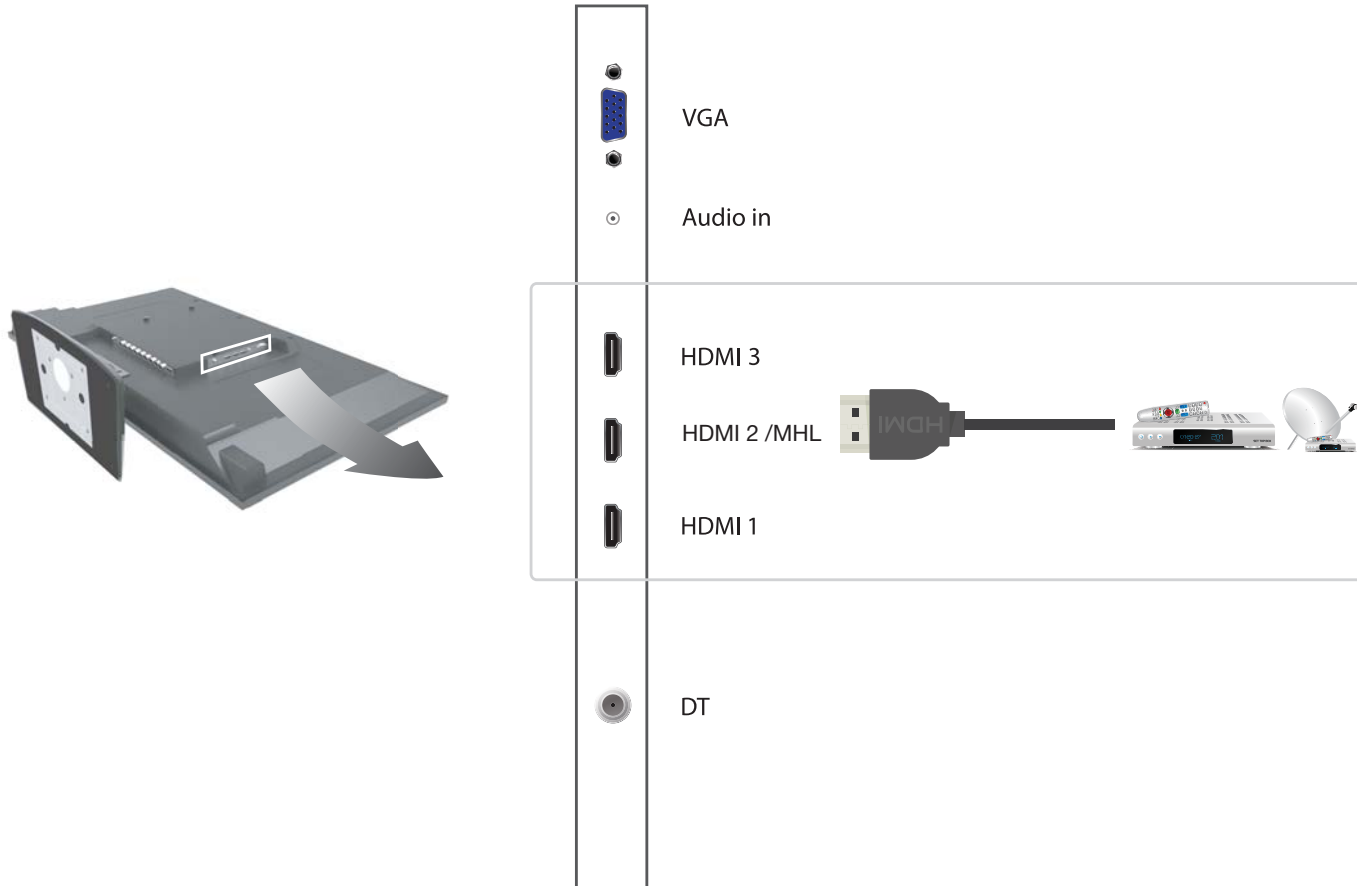

**THIS IS A HIGH DEFINITION SETUP**

Once you push in the HDMI cable on both the cable or satellite box and the TV, **you need to switch to the correct source to watch TV.**

1. Turn on the cable or satellite box.
2. Press POWER on your oCOSMO remote to turn on the TV.
3. Press the SOURCE button near the arrow buttons to open the source menu.
4. Use the ▲ or ▼ button to highlight the HDMI connection you plugged your HDMI cable to and press ENTER to select it.
5. You can now watch the TV.
6. **Be sure to use your cable or satellite box's remote to change channels.**

Please Note:

- To setup the cable or satellite box remote control for controlling the TV, please call the cable or satellite TV company and ask them for SONY® TV's universal remote code.

# Setup

If you want to connect a computer to the TV...

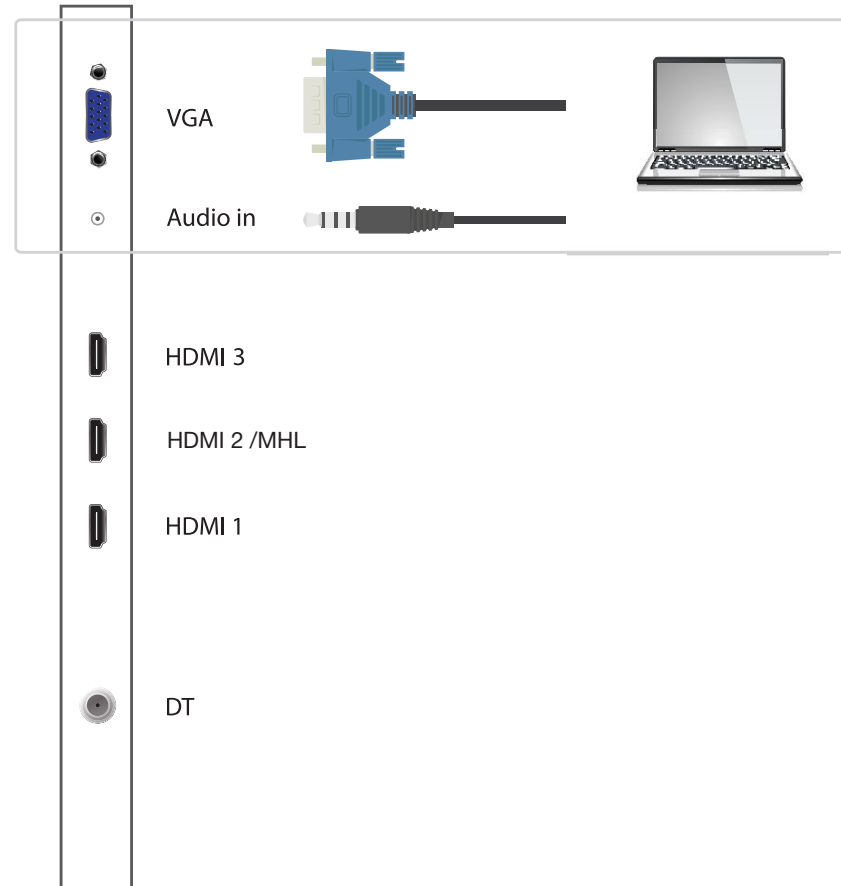

Once you securely tighten the VGA cable on both the computer and the TV and also push in the 3.5mm mini-jack for audio on both ends, **you need to switch to the correct source to use the TV as a computer monitor.**

1. Turn on the computer.
2. Make sure the resolution of the computer is **1920x1080 at 60hz refresh rate.**
3. Press POWER on your oCOSMO remote to turn on the TV.
4. Press the SOURCE button near the arrow buttons to open the source menu.
5. Use the ▲ or ▼ button to highlight PC as the source and press ENTER to select it.
6. You can now use the TV as a computer display.

Please Note:

- If the TV shows the message “NOT SUPPORT”, the signal is incompatible. Check the computer resolution and refresh rate. Can also try restarting computer.

If you want to connect a headphone to the TV...

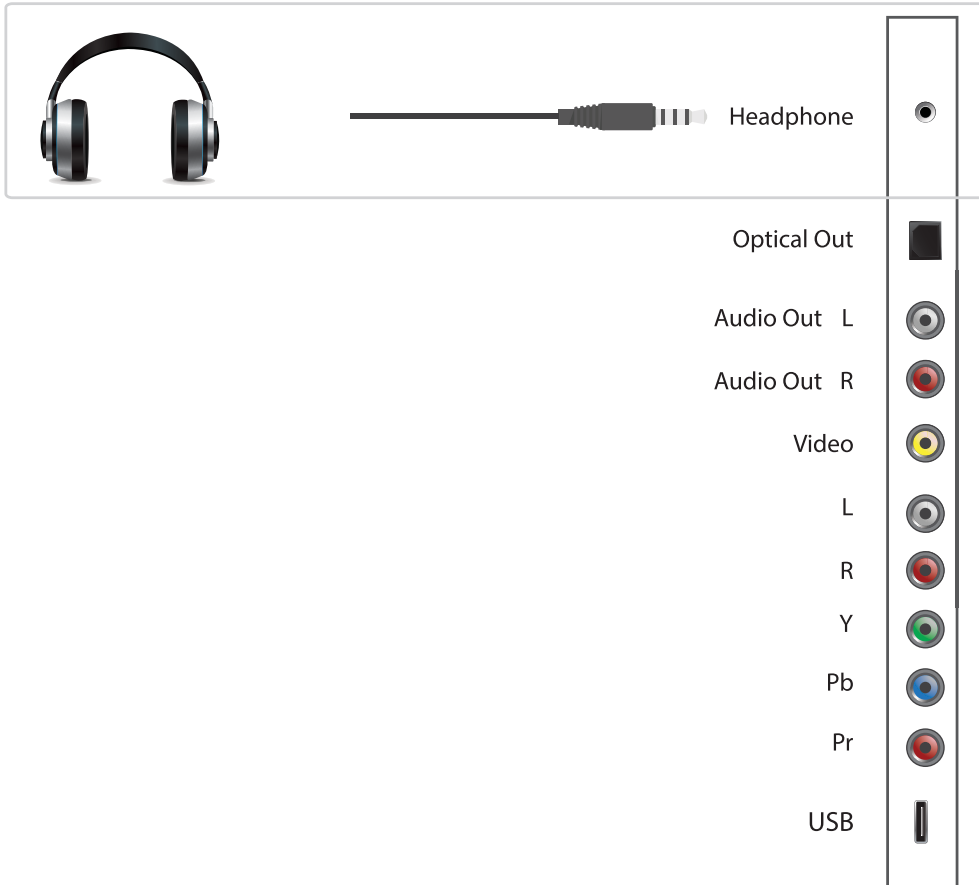

**Once you connect the headphone to the TV, the TV's speakers will automatically be muted.** You can control the volume by using the VOL+ or VOL- button on the TV's remote control.



# Setup

If you want to connect a digital surround sound receiver to the TV with optical out...

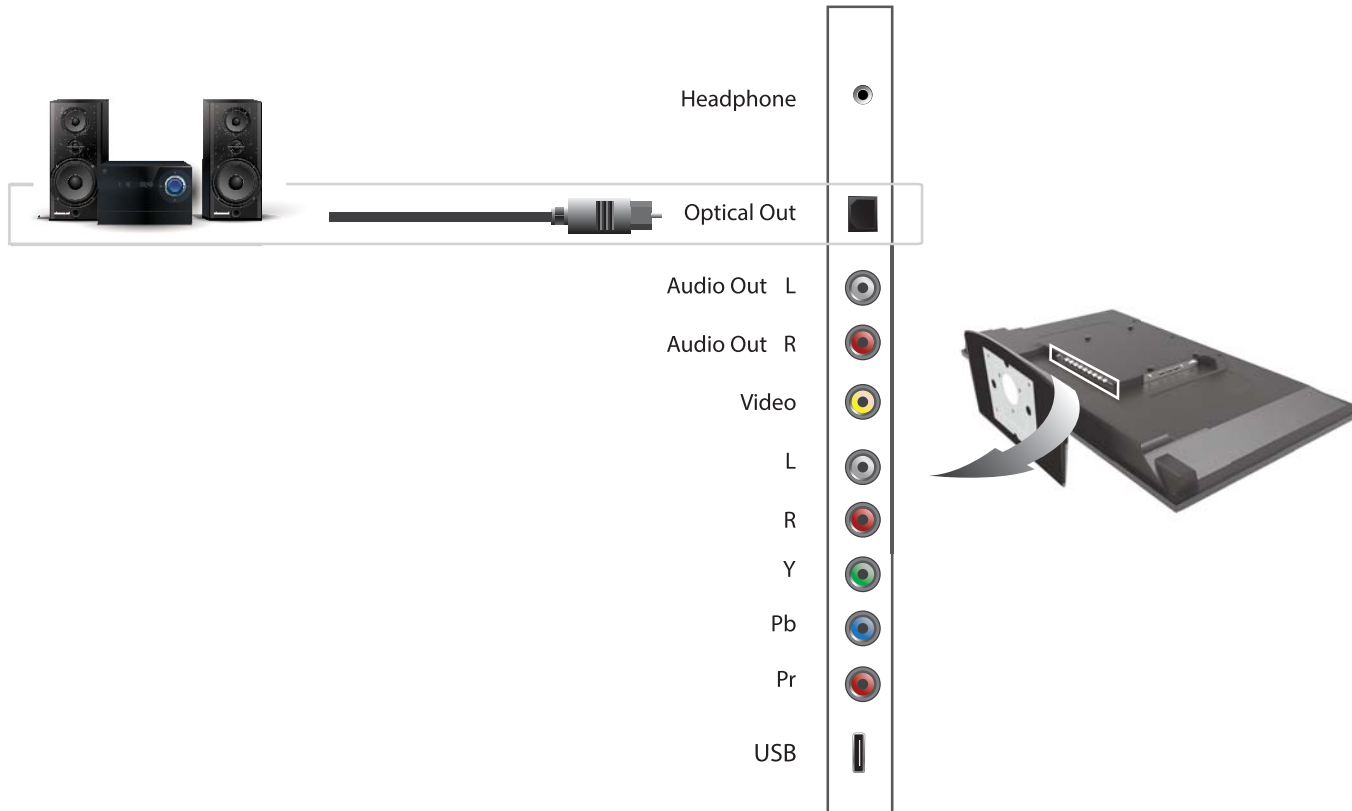

THIS IS A DIGITAL SURROUND SOUND SETUP

Once you plug the optical SPDIF cable into the TV's optical out and your surround sound's receiver digital optical in connection, the TV will automatically output digital sound signals to your receiver. You can change the sound signal output by going into the TV's menu.

1. Turn on your surround receiver and press POWER on the TV's remote to turn on the TV.
2. Press MENU to open up the TV's menu.
3. Navigate to the SOUND option by using the use the ◀ or ▶ button then select it with the ENTER button.
4. Use the ▲ or ▼ button to highlight the OTHER SETTINGS option and press ENTER to select it.
5. You can change the sound signal by highlighting DIGITAL AUDIO OUTPUT then using the ◀ or ▶ button to change the signal.

If you want to connect a stereo receiver to the TV with audio out...

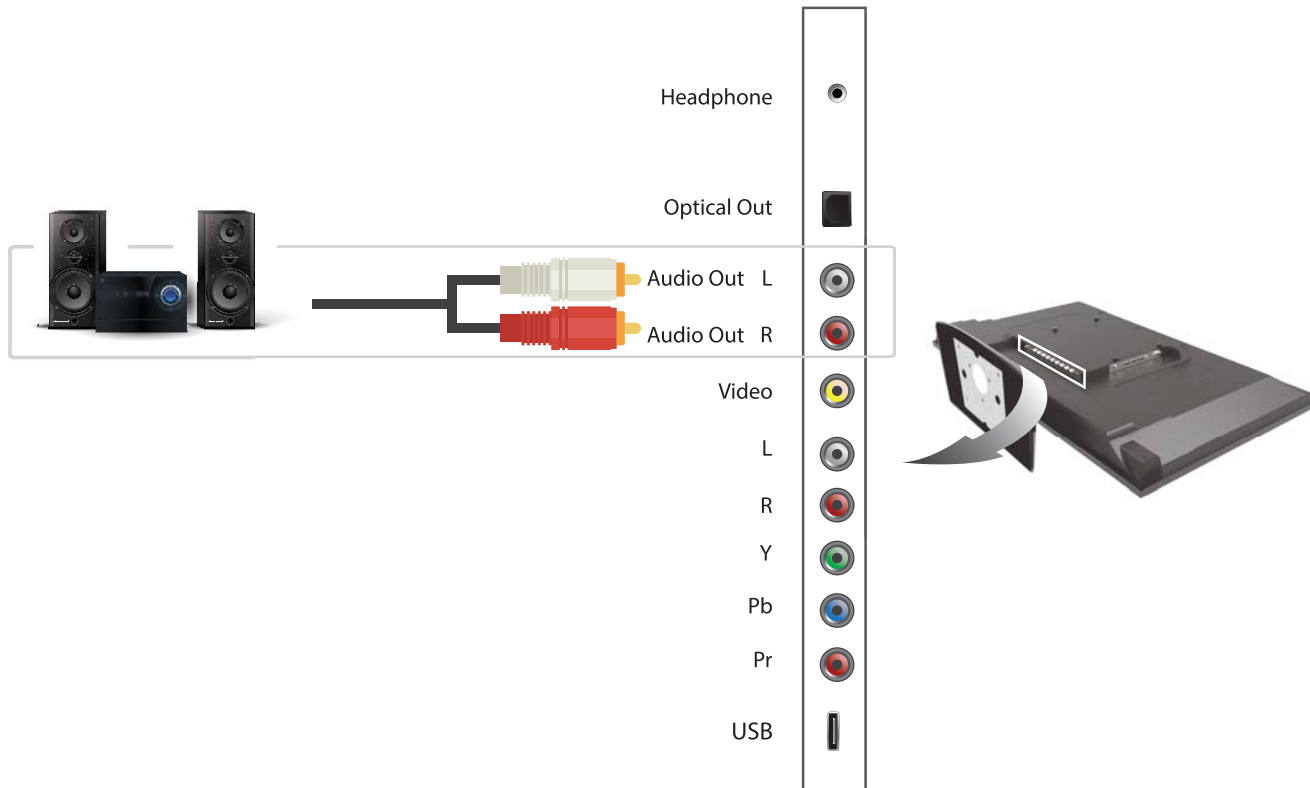

Once you plug the red and white audio plugs by matching the same colors on both the TV and the stereo receiver the TV will automatically output sound to the receiver.

Please Note:

- You cannot change the volume of the TV by using the TV's VOL(+/-) buttons. You need to use the receiver's volume controls to adjust volume.

THIS IS A STEREO AMPLIFIER SETUP

# Setup

If you want to connect a regular cable box, satellite box, or a DVD player with yellow, red, and white plugs...

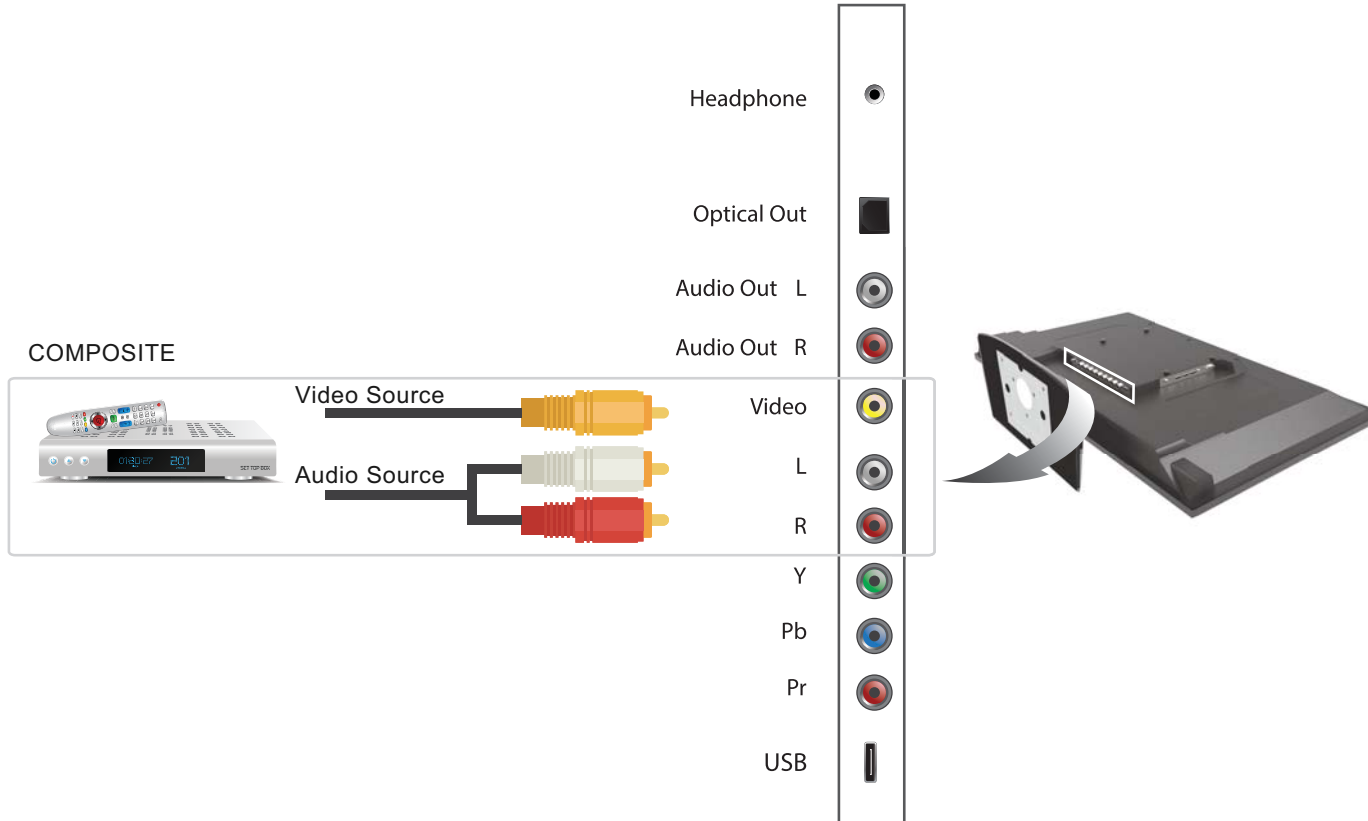

THIS IS A STANDARD DEFINITION SETUP

Once you plug in 3 colored plugs (yellow, red, and white) by matching the same colors on both the TV and the DVD player or cable/satellite box, **you'll need to change to the correct source in order to watch TV.**

1. Turn on the DVD player or cable/satellite box.
2. Press POWER on your oCOSMO remote to turn on the TV.
3. Press the SOURCE button near the arrow buttons to open the source menu.
4. Use the ▲ or ▼ button to highlight the AV connection and press ENTER to select it.
5. You can now watch the TV.
6. **Be sure to use your cable or satellite box's remote to change channels.**

Please Note:

- This setup shares the same audio connection with YPbPr. You can only use one or the other, not both.
- To setup the cable or satellite box remote control for controlling the TV, please call the cable or satellite TV company and ask them for SONY® TV's universal remote code.

## If you want to connect a HD cable or satellite box to the TV with YPbPr...

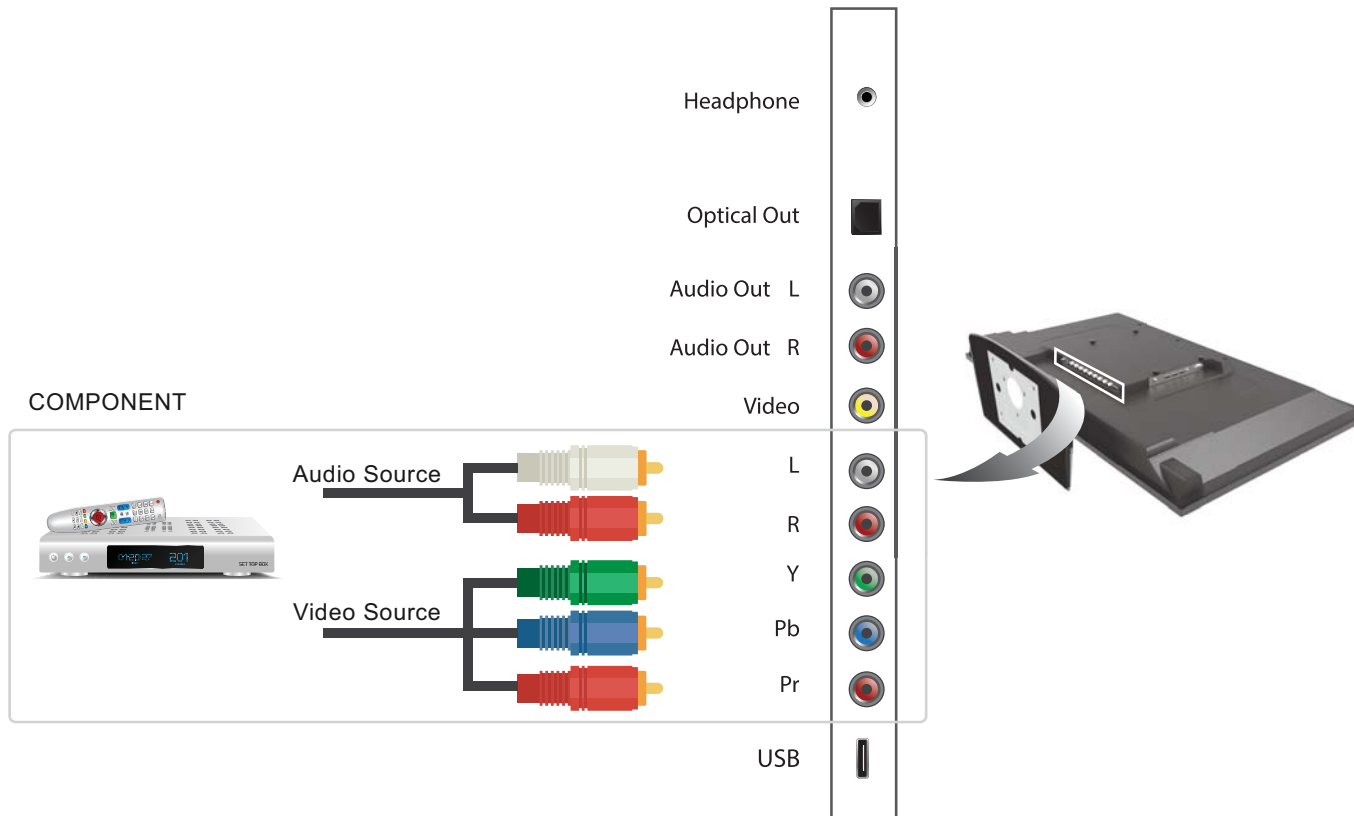

**THIS IS A HIGH DEFINITION SETUP**

Once you plug in 5 colored plugs (white, red, green, blue, and red) by matching the same colors on both the TV and the cable or satellite box, **you'll need to change to the correct source in order to watch TV.**

1. Cable or satellite box.
2. Press POWER on your oCOSMO remote to turn on the TV.
3. Press the SOURCE button near the arrow buttons to open the source menu.
4. Use the ▲ or ▼ button to highlight the YPbPr connection and press ENTER to select it.
5. You can now watch the TV.
6. **Be sure to use your cable or satellite box's remote to change channels.**

Please Note:

- This setup shares the same audio connection with AV. You can only use one or the other, not both.
- To setup the cable or satellite box remote control for controlling the TV, please call the cable or satellite TV company and ask them for SONY® TV's universal remote code.

# Setup

If you want to use the USB connection on the TV...

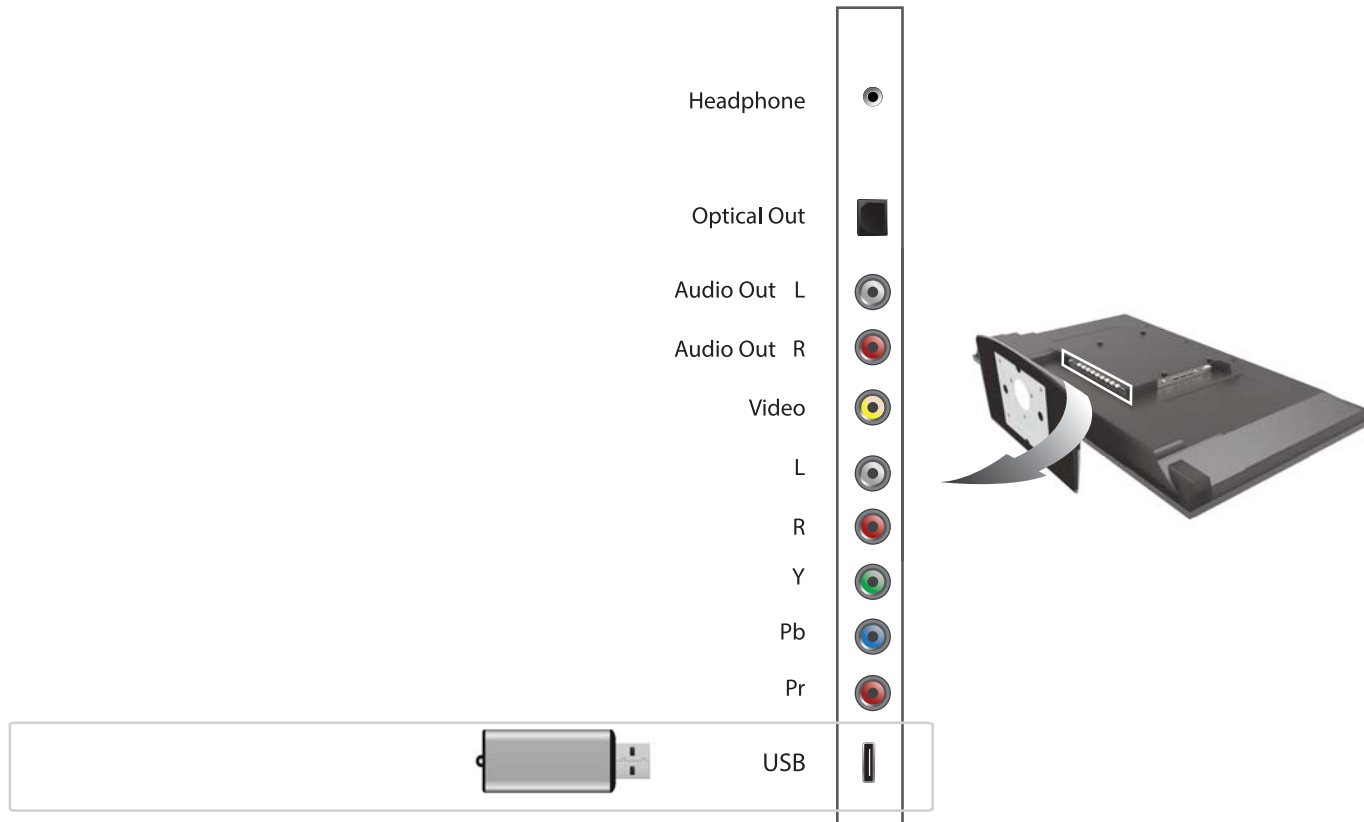

Once you plug in the USB flash drive into the USB connection on the back of the TV, press the USB button on the TV's remote control to display picture files or play music.

Please Note:

- **The USB connection on the TV only recognizes USB flash drives, any other USB storage device or USB peripherals will not work on the TV.**
- The TV only plays MP3 music files and JPEG non-progressive picture files.

# Operation

## Switching Video Sources on your TV

To switch video sources find the **S** button on the side of the TV and press it. Use CH (**▲/▼**) button to navigate up and down. **S** button is used as the select button.

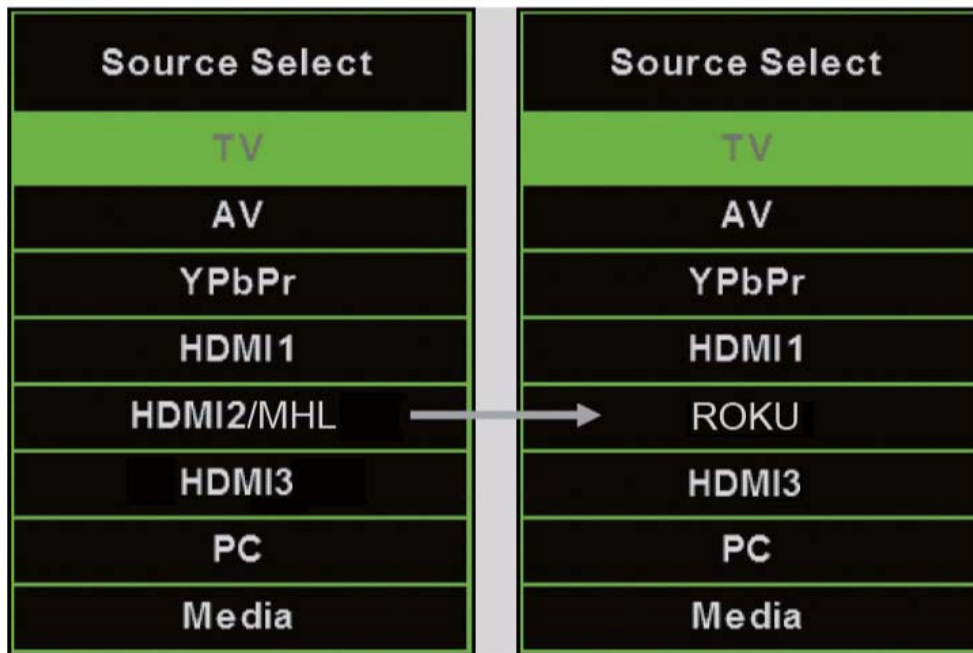

The source HDMI 2 / MHL will automatically display to the word ROKU if a ROKU streaming stick is connected.

## Navigating the TV Menu



To navigate the TV menu please use the directional buttons on the TV remote and the ENTER to select functions you want to change or use. You can also use the buttons on the TV to navigate the menu. Use CH(**▲/▼**) to navigate up and down and VOL(**+/-**) to navigate left and right. **ⓘ** opens and closes the menu. **S** is used as the select button.

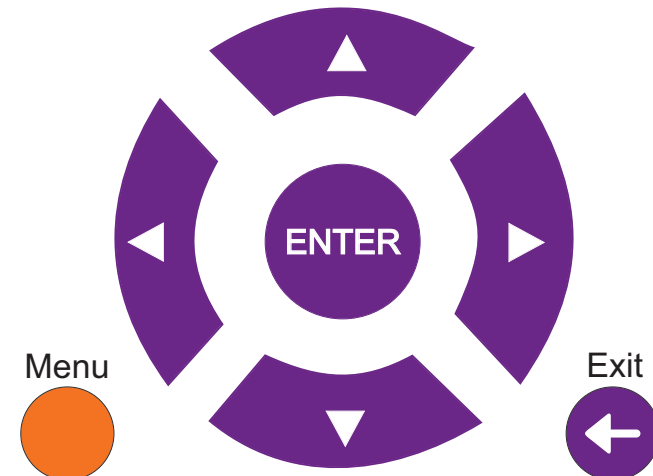

# Operation

## Using the TV Menu

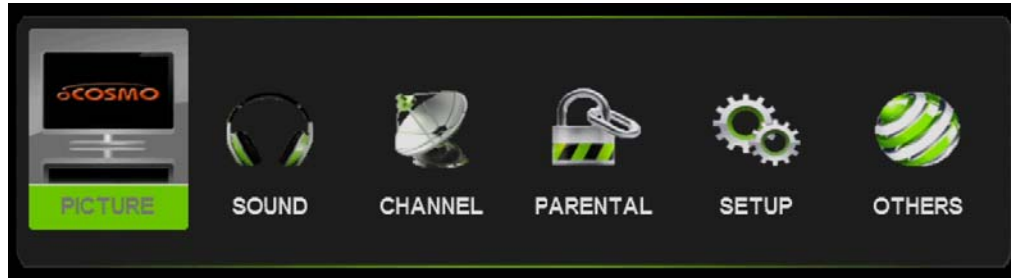

**PICTURE** - This option adjusts the picture quality with various settings such as tint, contrast, sharpness, and screen size.

**SOUND** - This option adjusts the sound quality with various settings such as bass, treble, equalizer and surround mode.

**CHANNEL** - This option adjusts the TV tuner functions such as scanning for antenna channels, and editing the favorite list.

**PARENTAL** - This option adjusts the V-chip parental guidance and blocking function for the sources TV and VIDEO.

**SETUP** - This option adjusts the TV menu's language, TV internal clock and closed captioning.

**OTHERS** - This option adjusts miscellaneous settings of the TV such as no signal power off and no operation power off.

## Picture

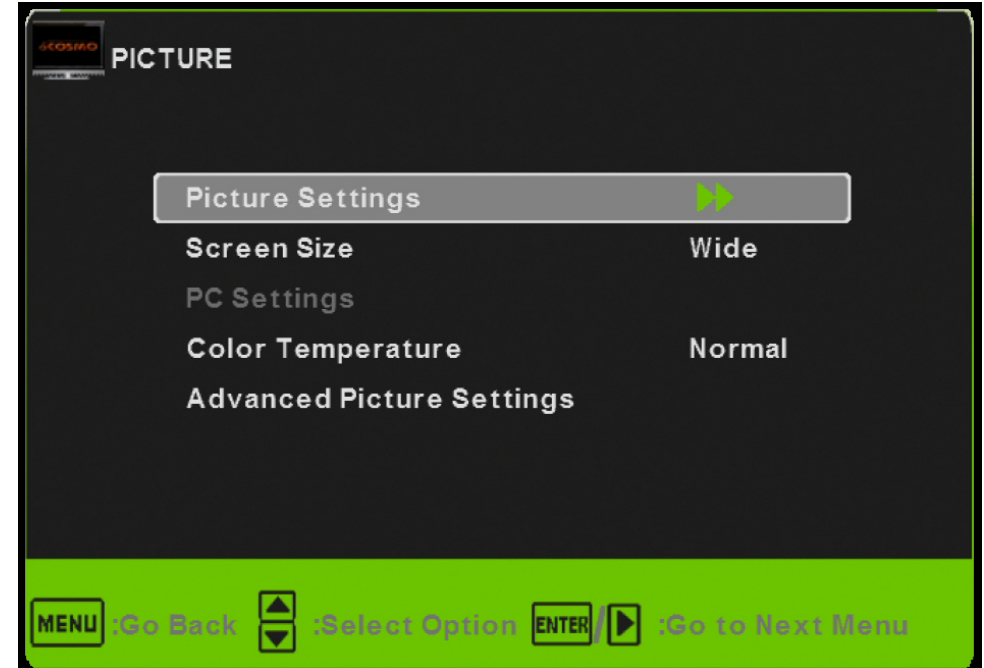

1. Press MENU to open the TV's menu.
2. Press ◀ or ▶ to select PICTURE and press ENTER.
3. Use ▲ or ▼ to select the one you want to adjust and ◀ or ▶ or ENTER to adjust them.

# Operation

**PICTURE SETTINGS:** This option gives various adjustments to the picture you are viewing.

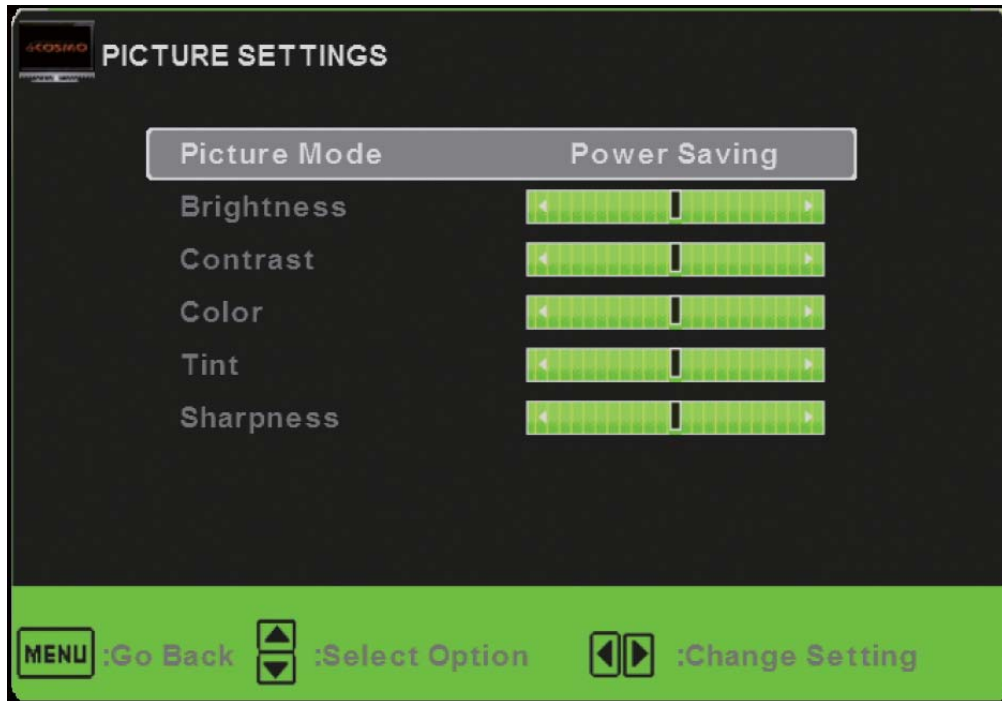

1. Picture Mode: This option changes various preset color and power saving modes for the TV.
2. Brightness: This option changes the picture's detail in dark colors.
3. Contrast: This option changes the difference between dark and bright objects.
4. Color: This option changes the amount of color in the picture.

5. Tint: This option changes the white balance in the picture.
6. Sharpness: This option changes the picture quality between blurry and smooth or sharp and pixilated.

**SCREEN SIZE:** This option adjusts the size of the picture displayed. On the remote you can use the ASPECT button to adjust the screen size.

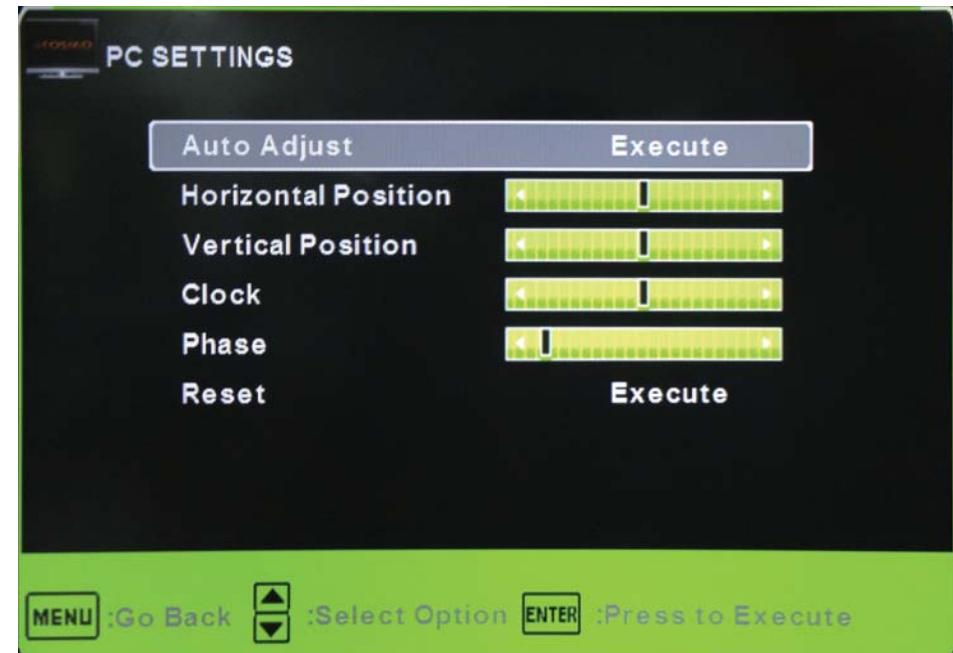

**PC SETTINGS:** This option adjusts syncing frequency that affects the VGA connection's picture quality.

1. Auto Adjust: This option automatically adjusts the picture syncing in with the signal of the TV.
2. Horizontal Position: This option adjusts the left or right po-



# Operation

sition of the PC picture.

3. Vertical Position: This option adjusts the up or down position of the PC picture.
4. Clock: This option tunes in large increments the syncing of the PC video signal.
5. Phase: This tunes in small increments the syncing of the PC video signal.
6. Reset: This option resets all the adjusted setting under PC SETTINGS.

**COLOR TEMPERATURE:** This option adjusts the general color of the entire picture from warm to cool.

**ADVANCE PICTURE SETTINGS:** This option contains various special picture functions.

1. Dynamic Contrast: This option allows the TV to automatically adjust the contrast of the TV depending on the picture you are viewing.
2. Film Mode: This option will enable the TV to support 24p mode for movies so that they will play smoother.
3. Noise Reduction: This option will reduce general pixilation by blurring them.
4. MPEG Noise Reduction: This feature reduce DVD video pixelation by blurring them.

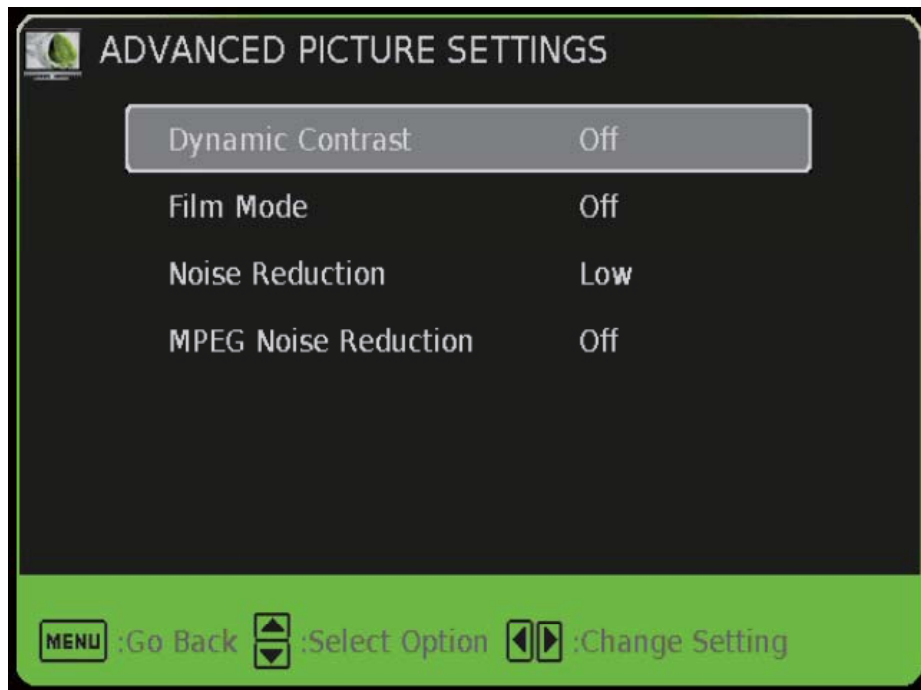

## SOUND

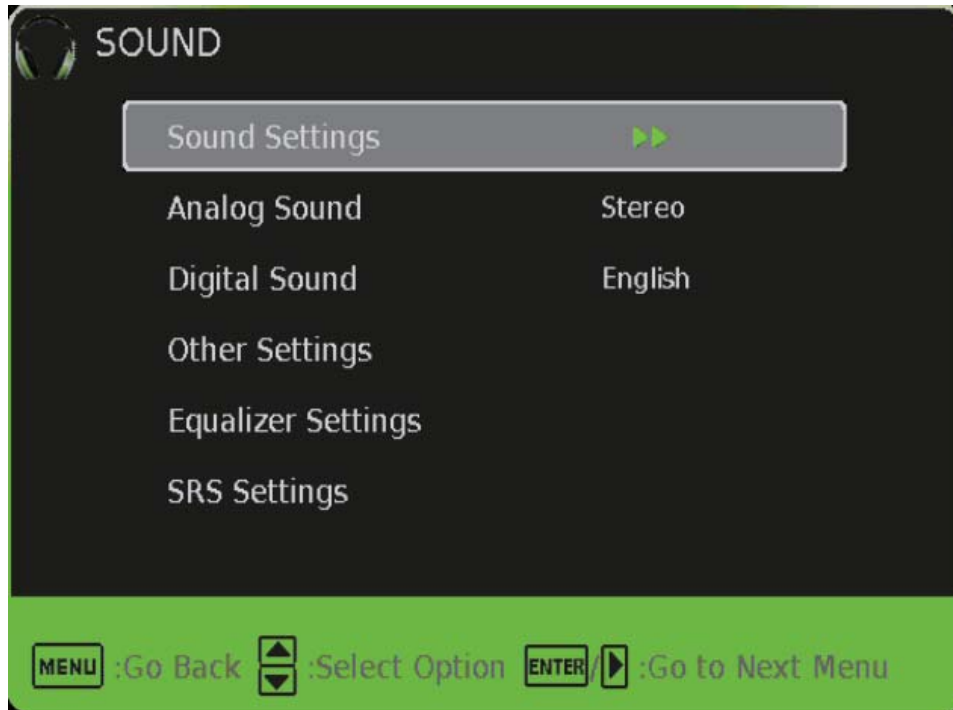

1. Press MENU to open the TV's menu.
2. Press ◀ or ▶ to select SOUND and press ENTER.
3. Use ▲ or ▼ to select the one you want to adjust and ◀ or ▶ or ENTER to adjust them.

**SOUND SETTINGS:** This option gives various adjustments to the sound you are listening to.

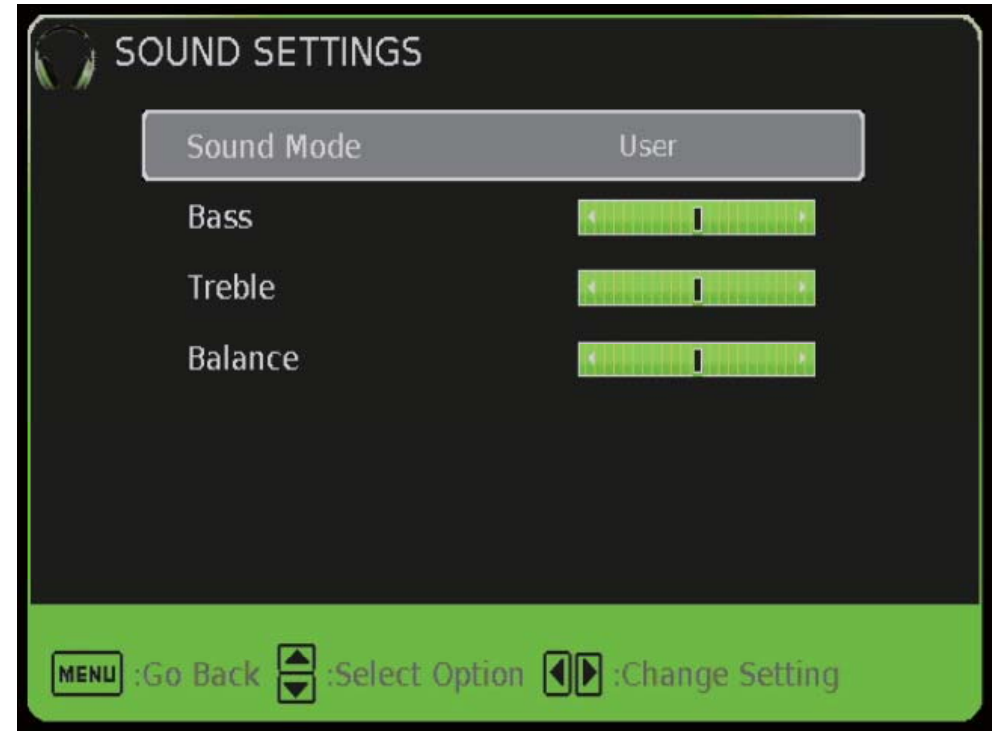

1. Sound Mode: This option switches between preset sound settings (standard, soft, user, and dynamic).
2. Bass: This option adjusts the audio bass level of the TV.
3. Treble: This option adjusts the audio treble level of the TV.
4. Balance: This option adjusts the balance between the two speakers moving the sound left to right.

# Operation

**SURROUND MODE:** This option enables the two speakers to provide a wider more surrounding sound effect.

**ANALOG SOUND:** This option adjusts the second audio programming in analog channels.

**DIGITAL SOUND:** This option adjusts the second audio programming in digital channels.

**OTHER SETTINGS:** This option offers various sound settings.

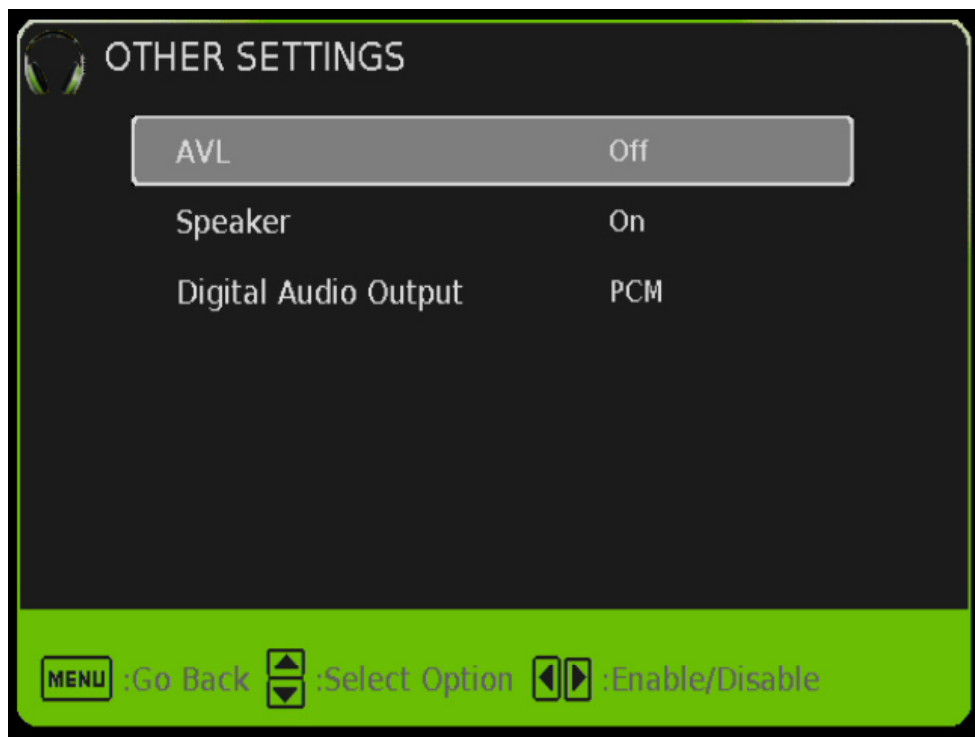

1. AVL: This option enables the TV to automatically adjust the volume of the TV program for you.

2. Speaker: This option turns the TV speakers on or off.

3. Digital Audio Output: This option adjusts the type of digital audio signal outputted by the TV (between PCM, and 5.1 CH).

**EQUALIZER SETTINGS:** This option allows the user to adjust the internal sound equalizer of the TV by either selecting built in preset modes or individual sound frequencies.

**SRS SETTINGS:** This option adjusts the SRS TruSurround HD, Dialog Clarity, Trubass, and Definition settings.

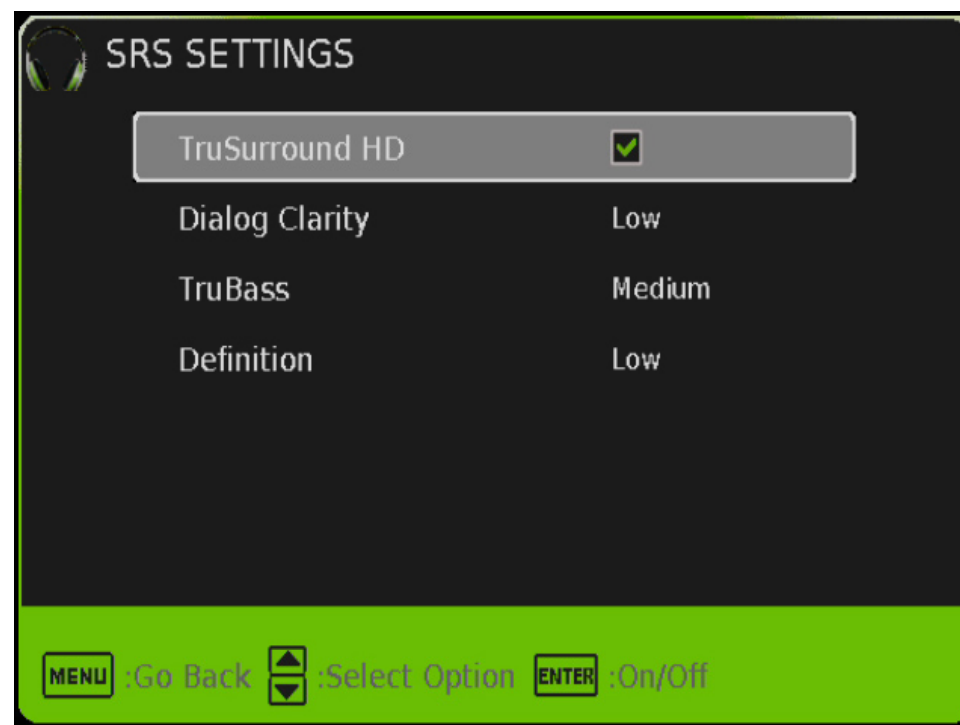

## CHANNEL

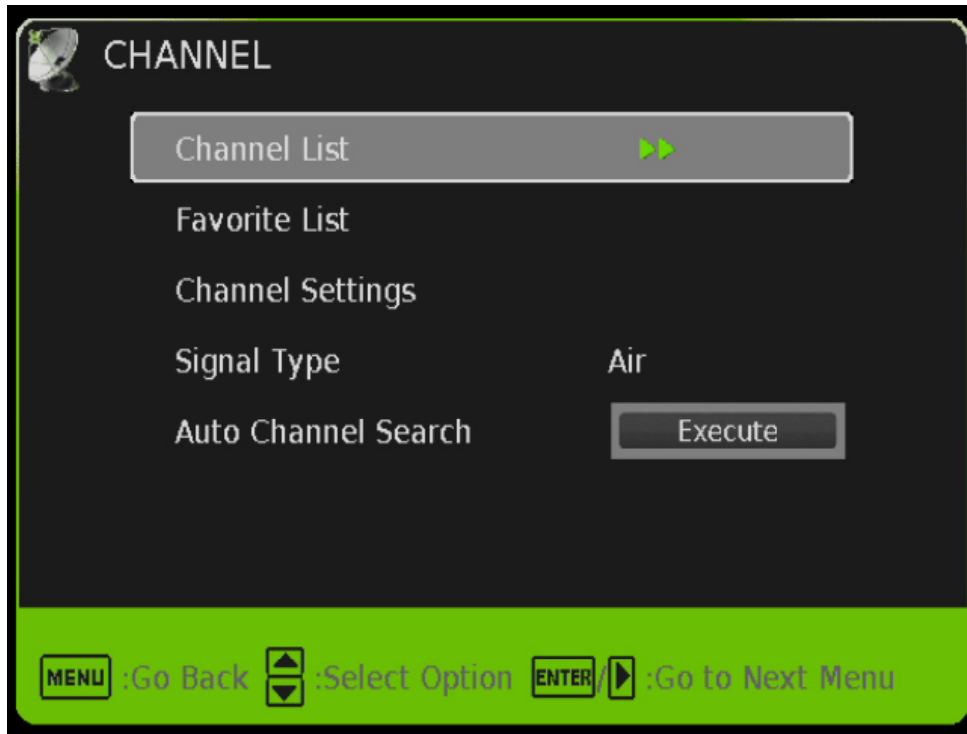

1. Press MENU to open the TV's menu.
2. Press ◀ or ▶ to select CHANNEL and press ENTER.
3. Use ▲ or ▼ to select the one you want to adjust and ◀ or ▶ or ENTER to adjust them.

Please Note:

- **The CHANNEL option is only available while you are under the source TV. You can only use this option with an antenna.**

**CHANNEL LIST:** This option shows you the current list of channels found through AUTO CHANNEL SEARCH.

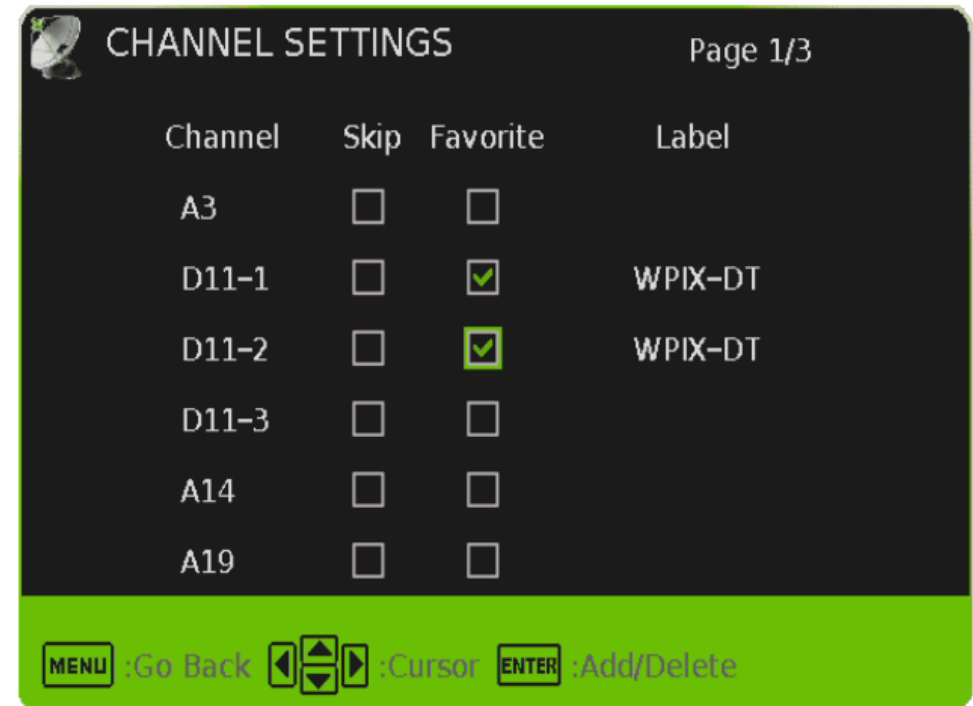

**FAVORITE LIST:** This option shows you the current list of favorite channels added.

**CHANNEL SETTING:** This option offers numerous adjustments for your scanned channels.

1. Channel Number: This option shows the current channel number.
2. Channel List: This option allows you to skip a channel from the channel list.

# Operation

3. Channel Label: This option changes the channel name.
4. Favorite Channel: This option allows the user to add or remove the current channel as a favorite channel.

**SIGNAL TYPE:** This option switches the digital tuner accepting signal between cable (for analog cable) or air (for antennas).

**AUTO CHANNEL SEARCH:** This option searches for the available TV channels while using analog cable or antenna.

Please Note:

- QAM for digital cable is not supported by this TV.

## PARENTAL

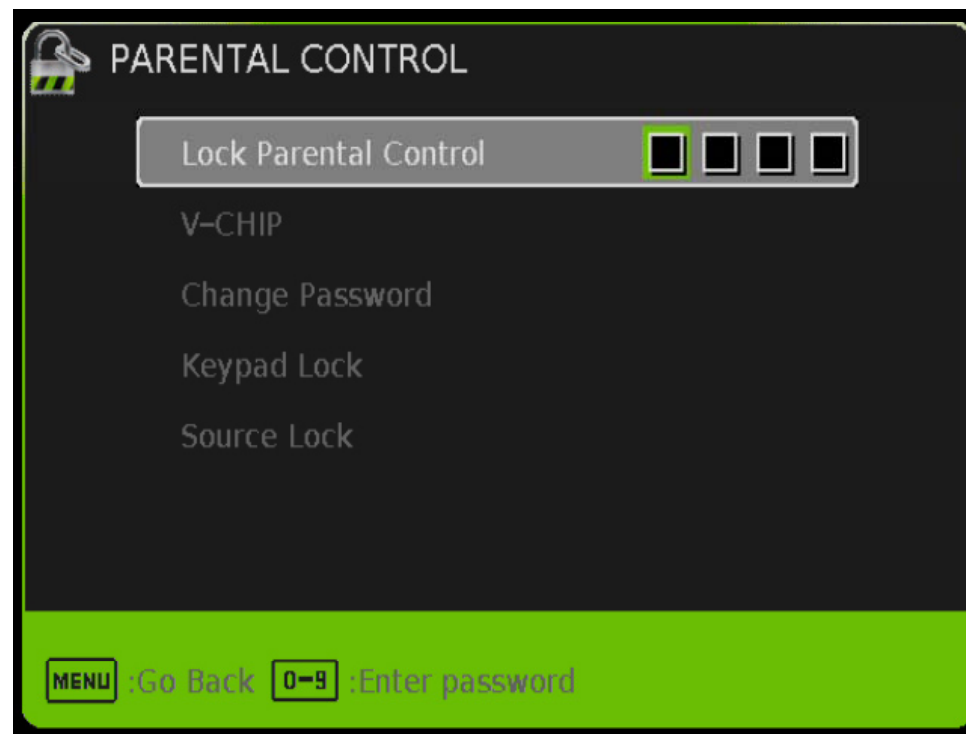

1. Press MENU to open the TV's menu.
2. Press ◀ or ▶ to select PARENTAL and press ENTER.
3. Use ▲ or ▼ to select the one you want to adjust and ◀ or ▶ or ENTER to adjust them.

**LOCK PARENTAL CONTROL:** This option locks the parental control. You'll need to put in a password to access all other features. The default password is 0000.

**V-CHIP:** This option blocks TV shows under the digital tuner.

1. **US V-CHIP:** Movie rating blocks movies played under the digital tuner while receiving US TV broadcasting signals. TV rating blocks TV sitcoms and shows under the digital tuner while receiving US TV broadcasting signals.
2. **CANADA V-CHIP:** English rating blocks TV shows with the english language. French rating blocks TV shows with the french language.
3. **Block Unrated Show:** This option blocks any TV programing that does not have any rating.
4. **Downloadable Rating:** This is a option under the new V-CHIP where ratings can be downloaded from the channel.
5. **Clear Downloadable Data:** This option clears the memory buffer of the downloaded ratings.

**CHANGE PASSWORD:** This option changes the LOCK PARENTAL CONTROL option's password.

**KEYPAD LOCK:** This option locks the buttons on the TV from functioning except for the power button.

**SOURCE LOCK:** This option locks the video sources from working.

Please Note:

- Please refer to RATINGS EXPLAINED for more information on ratings definitions.
- The downloadable rating and clear downloadable data options might be grayed out. Their functionality depends on local TV stations' support.

## SETUP

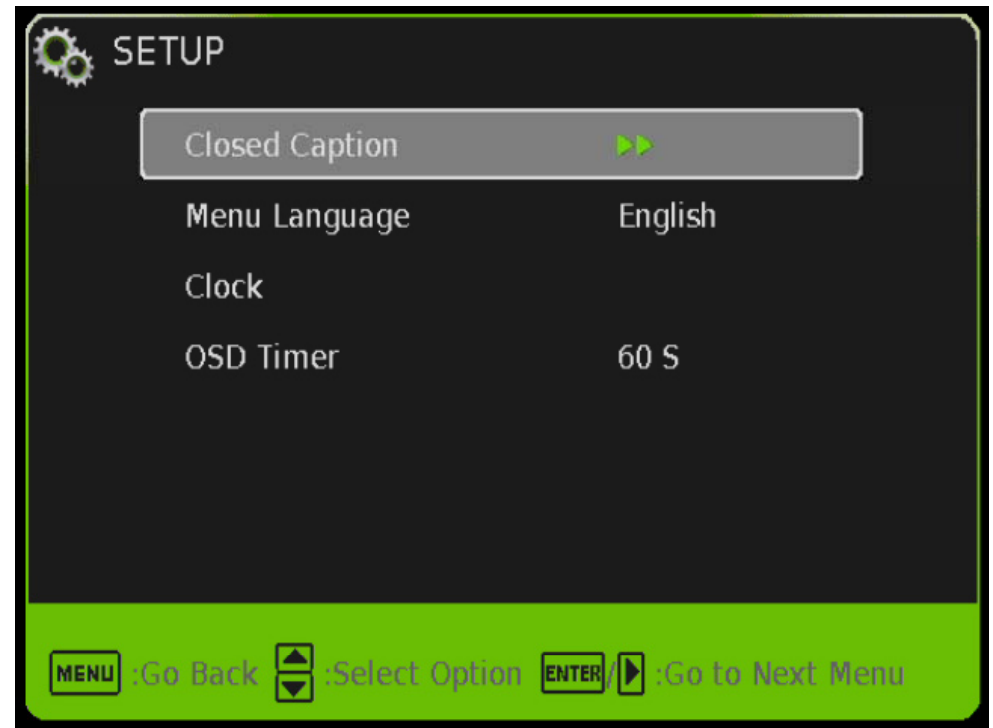

1. Press MENU to open the TV's menu.
2. Press ◀ or ▶ to select SETUP and press ENTER.
3. Use ▲ or ▼ to select the one you want to adjust and ◀ or ▶ or ENTER to adjust them.

# Operation

**CLOSED CAPTION:** This option provides subtitles for TV shows and movies played on TV while using the sources TV and AV.

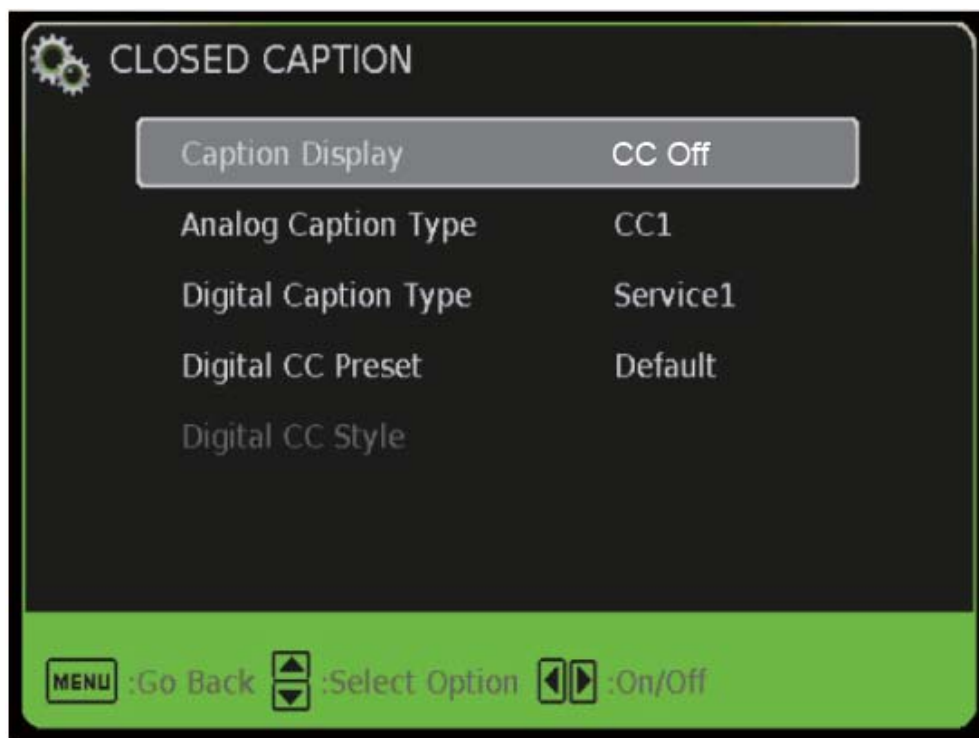

1. Caption Display: This turns on or off the closed captioning.
2. Analog Caption Type: This option chooses the subchannel that supplies the closed captioning. For United States, usually the setting is CC1. TEXT1-4 displays advertisements of the channel.
3. Digital Caption Type: This option chooses the subchannel

for digital channel closed captioning. For United States, usually the setting is Service1.

4. Digital CC Preset: This option unlocks the user's ability to change caption styles.
5. Digital CC Style: This option lets the user change the way digital caption on the TV is displayed with options (size, font, opacity, text color, background opacity and background color).

**MENU LANGUAGE:** This option changes the language of the TV menu between English, French, and Spanish.

**CLOCK:** This option changes the internal clock of the TV.

1. Time Zone: This option adjusts the time zone of the clock.
2. Auto Clock: This option sets the TV to the TV channel's clock (You must have an antenna to use this feature).
3. Setup Time: This option adjusts the time and date.
4. Day Of The Week: This shows you the day of the week.
5. Daylight Savings Time: This option toggles daylight savings time adjustment.
6. 24 Hour Mode: This feature tells time in a 24 hour fashion instead of showing AM and PM.

**OSD TIMER:** This option adjusts the idle time that the TV's menu stays on the screen.

Please Note:

- Closed captioning is only available with source AV and TV.
- Closed captioning is dependent on your local TV station.
- TEXT1-4 will give you block boxes in the middle of the screen if there are no information to broadcast.

## OTHERS



1. Press MENU to open the TV's menu.
2. Press ◀ or ▶ to select OTHERS and press ENTER.
3. Use ▲ or ▼ to select the one you want to adjust and ◀ or ▶ or ENTER to adjust them.

**BLUE BACK:** This option changes the black background of the TV when there is nothing to display to blue color.

**NO SIGNAL POWER OFF:** This option turns the TV off automatically after the TV has received no signal for a certain time.

**NO OPERATION POWER OFF:** This option turns the TV off automatically after the TV has received no remote control command for a certain period of time.

**ALL RESET:** This option resets the entire TV menu and wipes all memory from the channels scanned in by the TV.



# Operation

## Detailed Explanations

### USB Connection Explained

This TV is a widescreen TV with an USB port. With the USB port the TV can access USB flash drives (up to 2GB) and display JPEG pictures or play MP3 files. To use this feature connect a USB flash drive to the USB port of the TV and press the USB button to start browsing for music and pictures.



Once you press the USB button the USB menu will come up. Select either the music or picture you want to browse using the arrow buttons. Press the ENTER button to select the file you want.



### Browsing Music and Photo

In the USB function, select Music or Photo.

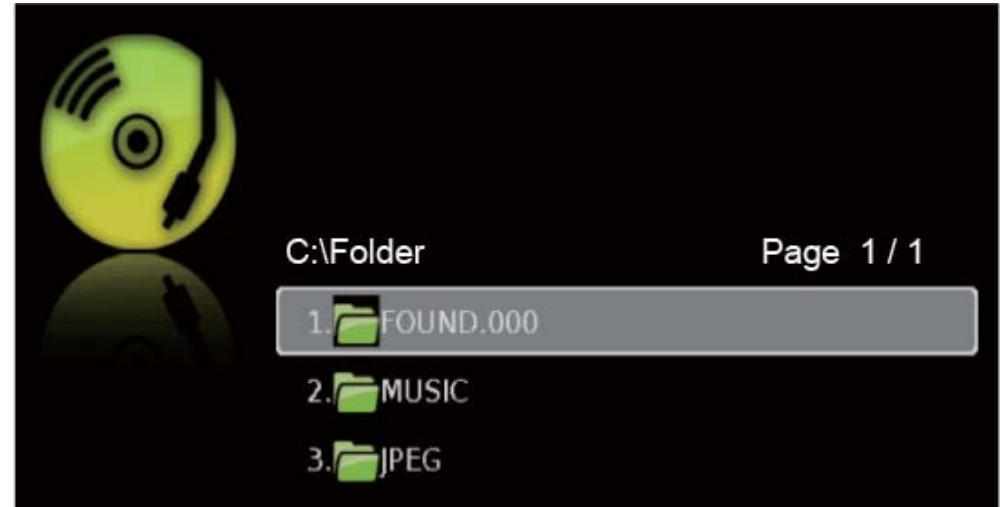

Use the ▲ or ▼ button to select the file you want and use the ENTER to play the file. Use the EXIT button to exit a folder.

### Media Setting



# Operation

1. SLIDESHOW INTERVAL – This option adjusts the time interval of a displayed picture.
2. SLIDESHOW EFFECT – This option adjusts the video effects when pictures interchange.
3. SLIDESHOW REPEAT – This option toggles the repeat function for displaying pictures.
4. MUSIC PLAY MODE – This option adjusts the music playing option.
5. MUSIC PLAY REPEAT – This option toggles the repeat function for playing music.
6. MUSIC AUTO PLAY – This function toggles the auto play feature which will play any music found in the USB flash drive once you insert the flash drive.

## Technical Limitation

1. The USB port does not support USB hubs.
2. The USB port does not support USB hard drives or USB peripherals.
3. The USB flash drive supports FAT32 and FAT16 file system only.
4. The biggest file size is 2 gigabyte (FAT32).
5. The picture function only supports JPEG file (baseline only, progressive is not supported).
6. The music function only supports MP3 that is from 32-48k Hz using a data rate of 32-320 kbps.
7. All USB functions are operated by the remote control. None of the buttons physically located on the TV will respond to USB functions.

## Closed Captioning Explained

Your TV is equipped with an internal Closed Caption decoder. It allows you to view conversations, narration and sound effects as subtitles on your TV. Closed Captions are available on most TV program, and on some VHS home video tapes, at the election of the program provider.



CC – Press this button to enable the CC function. You can then use the ▲▼ buttons to select if you want CC off or CC on. You can use the ◀▶ buttons to select between different CC channels.

### Please Note:

- Digital Closed Caption service is a new caption service available on digital TV programs (also at the election of the service provider). It is a more flexible system than the original Closed Caption system, because it allows a variety of caption sizes and font styles.
- Not all programs and VHS video tapes offer closed captioning. Please look for the CC symbol to ensure that captioning is available.

# Operation

tions will be shown.

- In the Closed Caption system, there can be more than one caption service provided. Each is identified by its own number. The CC1 and CC2 services display subtitles of TV programs superimposed over the program's picture.
- In the Closed Caption system, the TEXT1 or TEXT2 services display text that is unrelated to the program being viewed (e.g., weather or news). These services are also superimposed over the program currently being viewed.
- Closed Captioning for this TV only works under sources TV, and VIDEO.

## TV Ratings Explained

### General Operation

To block channels you don't want your children to watch, you can filter them with the ratings function. MPAA lets you control ratings for movies. For regular TV programs you can use USTV settings. USTV settings lets you filter what content you want at each age level, TV-Y, to TV-MA (refer to definitions below). Below are definitions for each setting.

### USTV Rating

TV-Y (USTV) – For All Children

This program is designed to be appropriate for all children. Whether animated or live-action, the themes and elements in this program are specifically designed for

a very young audience, including children from ages 2-6. This program is not expected to frighten younger children.

TV-Y7 (USTV) – Directed to Older Children

This program is designed for children age 7 and above. It may be more appropriate for children who have acquired the developmental skills needed to distinguish between make-believe and reality. Themes and elements in this program may include mild fantasy violence or comedic violence, or may frighten children under the age of 7. Therefore, parents may want to consider the suitability of this program for their very young children. Note: For those programs where fantasy violence may be more intense or more combative than other programs in this category, such programs will be designated TV-Y7-FV.

TV-G (USTV) – General Audience

Most parents would find this program suitable for all ages. Although this rating does not signify a program designed specifically for children, most parents may let younger children watch this program unattended. It contains little or no violence, no strong language and little or no sexual dialogue or situations.

TV-PG (USTV) – Parental Guidance Suggested

This program contains material that parents may find unsuitable for younger children. Many parents may want to watch it with their younger children. The theme itself may call for parental guidance and/or the program contains one or more of the following: moderate violence (V), some sexual situations (S), infrequent coarse language (L), or some suggestive

dialogue (D).

**TV-14 (USTV) – Parents Strongly Cautioned**

This program contains some material that many parents would find unsuitable for children less than 14 years of age.

Parents are strongly urged to exercise greater care in monitoring this program and are cautioned against letting children under the age of 14 watches unattended. This program contains one or more of the following: intense violence (V), intense sexual situations (S), strong coarse language (L), or intensely suggestive dialogue (D).

**TV-MA (USTV) – Mature Audience Only**

This program is specifically designed to be viewed by adults and therefore may be unsuitable for children under 17. This program contains one or more of the following: graphic violence (V), explicit sexual activity (S), or crude indecent language (L).

TV program description

FV - Fantasy Violence

V - Violence

S - Sexual Situations

L - Adult Language

D - Sexually Suggestive Dialog

**MPAA Rating**

**G (MPAA)**

General audiences. All ages admitted.

**PG (MPAA)**

Parental guidance suggested. Some material may not be suitable for children.

**PG-13 (MPAA)**

Parents strongly cautioned. Some material may be inappropriate for children under 13.

**R (MPAA)**

Restricted. Under 17 requires accompanying parent or adult guardian (age varies in some jurisdictions).

**NC-17 (MPAA)**

No one 17 and under admitted.

**X (MPAA)**

X is an older rating that is unified with NC-17 but may be encoded in the data of older movies.

# Operation

## TV Aspect Ratio Explained

This TV is a widescreen TV, but a lot TV programs are still broadcasting in a square format, therefore the TV is offering multiple ways of viewing videos. There are mainly two types of signal format, Full (16:9 format), Normal (4:3 format), while others offer a novel ways to view the TV. Simply use the ASPECT button on the TV's remote control to cycle between the multiple modes.

### **NORMAL**

Most analog TV channels have 4:3 signal formats. If the original 4:3 aspect ratio (1.33:1 source) is preserved, black bars are added to the left and right of the display image. This aspect keeps that aspect ratio and shows you the black bars on the side.

### **WIDE**

This mode will stretch the picture to a widescreen ratio. If you have a perfect 16:9 ratio picture you will not see any black bars. If you are watching a widescreen movie in 1.85:1 or 2.35:1 ratio, you will still get black bars on the top and bottom of the screen. If you use this mode on 4:3 pictures they will be stretched and distorted horizontally.

### **CINEMA**

This mode cuts off all 4 sides to try to make a widescreen movie fit better on the TV screen.

### **ZOOM**

When watching a 4:3 aspect ratio TV or movie, this mode zooms in to cut off most of the black bars on the side while preserving the 16:9 ratio. Because of the zoom, the top and bottom are cut off as well.

### **Full 100%**

This mode is only available under DTV and HDMI. It will map dot by dot to the screen. Any resolution will be proportionate.

## Browsing Channels

Browsing through the entire channel list on the TV can be tedious. This TV features a favorite channel list, where you can add in channels that you always want to watch



### **TO ADD TO THE FAVORITE LIST**

1. Go to any channel you would like to include in your favorites list.
2. Press the ADD/DEL button on the remote control. You will see a (FAV) on the INFO banner denoting that this channel is in the favorites list.

### **TO DELETE FROM THE FAVORITE LIST**

1. Go to any channel you would like to remove from your favorites list.
2. Press the ADD/DEL button on the remote control. You will then see the (FAV) disappear on the INFO banner denoting that this channel is no longer in the favorites list.

### **BROWSING CHANNELS WITH THE FAVORITE LIST**

1. Press the FAVORITE button, and the list of channels you have added will be in a window.
2. Use the ▲ or ▼ buttons to select the channel you want to jump to and press ENTER to confirm.
3. You can also use the FAV+/- keys to switch up and down the favorites list automatically.

# Maintenance

## Cleaning the TV

### IMPORTANT

1. The power cable has to be removed from the socket before cleaning the TV.
2. Do not use volatile solvent (alcohol, rosin, and toluene) to clean the TV. These types of chemicals might damage the housing and the LCD glass.

### Cleaning the bezel and remote control

1. Use a 100% cotton cloth or micro-fiber cloth for cleaning.
2. If the remote control or bezel is dirty to the point where you cannot simply dry wipe it, please lightly dampen the cloth (the cloth cannot be dripping wet, because if water drips into the panel it will cause malfunction and possible permanent damage to the panel which will not be covered under the warranty) with clean water and wipe again. Wipe the display with a dry micro-fiber cloth or 100% cotton cloth afterwards.

### Please Note :

- Make sure you wring the water out of the cloth before cleaning the bezel or remote in order to prevent water from penetrating into the electronics.

### Cleaning the Screen

1. Use a 100% cotton cloth or micro-fiber cloth for cleaning.
2. The LCD screen glass is extremely fragile. Do not scrape it with any material. Do not press or tap the screen to avoid cracking. When the screen is dirty to the point where you cannot simply dry wipe it, please lightly dampen the wiping material with clean water and wipe again. Wipe the display with a dry micro-fiber cloth or 100% cotton cloth afterwards.

## Frequently Asked Q&As

Q: How do I program my cable or satellite remote to control my TV?

A: Call up your cable or satellite TV company and ask for SONY®TV's universal remote code.

Q: Does this TV support digital cable without a box?

A: No, this TV does not have a QAM tuner built in.

Q: Why is there no video after I connected my cable / satellite box to the TV with yellow, red, and white plugs but TV shows no video.

A: Press the SOURCE button on the remote, make sure you are on the source called AV. Please also reference page 27 under setup to confirm you did connect the cables in the correct place.

Q: Why is there no video after I connected my antenna?

A: You need to use the TV menu to scan for channels.

Q: Why is there no video after I connected my cable / satellite box with coax cable (the old style cable with needle in the middle and a ring to tighten the connection)?

A: Did you make sure to switch the signal type to cable and change your TV channel to the correct one? Check page 28 for more instructions.

# Maintenance

---

Q: How come the TV's clock isn't completely accurate?

A: The TV's digital clock needs to sync to a local TV station through the antenna signal to keep accurate time.

Q: Why does the TV show not support or HDCP fail?

A: The HDMI device you are using is not syncing correctly with the TV. Turn both the TV and your HDMI device off. Make sure the HDMI cable is plugged in correctly by unplugging both ends then plugging them back in. Turn on the TV, then turn on the HDMI device. If this still does not work, please contact technical support for further assistance.

Q: Why is the picture on the TV very dim or dark?

A: Make sure the TV is not under POWER SAVING mode. Press the PICTURE button on the TV's remote repeatedly to cycle through different picture modes.

Q: Why is there no color or weird colors on my TV screen?

A: Did you connect your cable correctly? Consult the SETUP section of this manual to make sure your cables are connected properly. If the TV worked before but does not any longer, you'll need to contact our technical support team for help.

Q: My remote doesn't respond, what do I do?

A: Turn off the TV, unplug it from the socket. Remove the batteries out of the remote for 15 minutes. Press the remote buttons and the power button randomly for a good 2 seconds,

and then reinstall the batteries. Try the remote to see if it works. If this did not work please contact our technical support team for help.

Q: Why is my picture blurry?

A: Press the INFO button on the TV's remote control. If you do not see 720P or 1080i or 1080P you are not seeing a HD signal, and the picture will be blurry because this is a TV built for HD video.

Q: Why is there a big black box in the middle of my screen?

A: You have the closed captioning TEXT service turned on. Turn off closed captioning or make sure your captioning service is on service1 or cc1 to turn off the black box but still receive regular closed captioning.

Q: Why is my picture cut off?

A: Press the ASPECT button on the TV's remote control repeatedly and make sure you are using WIDE or Full 100% aspect. If the picture is still cut off maybe you have a cable or satellite box that is controlling the signal. Use your cable or satellite box remote control and see if there is a zoom or scale button you can use to change the picture.

Q: Why do I only have 5-10 channels under the TV source?

A: Check the TV's menu for SIGNAL TYPE under CHANNEL. If you have antenna, please use AIR as your signal type. If

# Maintenance

---

you have cable without a box please use CABLE as your signal type and use the AUTO CHANNEL SEARCH option to find your channels.

**Q:** Why can't I get the resolution I want from my computer when it's connected to this TV?

**A:** Make sure the TV is recognized as a plug and play monitor under your computer. If not then there is something wrong with the cable you are using. Also make sure your video card does support widescreen resolutions by updating the video card drivers to the latest version.

**Q:** Why does my MP3 player or USB hard drive not work when I connect it to the TV's USB port?

**A:** The TV's USB port only works with USB flash drives, nothing else.

**Q:** Why do I see invisible lines moving up the TV or distortion on the TV?

**A:** The TV is receiving interference from another electrical device either close to the TV or on the same power grid as the TV. Try moving the TV away from the device.

**Q:** Why does my TV picture have a black border?

**A:** You need to use HDMI as your source to watch a HD picture. Also make sure your HD device (blu-ray player, satellite or cable box) is configured to output HD signals.

## Call Us If You Need Help

---

Products are often returned due to a technical problem rather than a defective product that may result in unnecessary shipping charges billed to you. Our trained support personnel can often resolve the problem over the phone or email. For more information on warranty services or repairs after the warranty period, please contact our support department at the number below.

For technical help, contact our oCOSMO Technical Support Group via email or phone. Please have your oCOSMO p/n number, serial number, and date of purchase available before you call.

Operation Hours: Mon - Fri at 8:30 AM – 5:30 PM (PST)

Telephone: 1855-662-6766

Technical Support E-mail: [ocosmots@ocosmo.com](mailto:ocosmots@ocosmo.com)

Customer Service Email: [ocosmocsa@ocosmo.com](mailto:ocosmocsa@ocosmo.com)



# Specification

## Panel

### Active Screen Size

40 class 40" (measured diagonally) viewable

### Aspect Ratio

16 : 9

### PC Resolution

1920 x 1080

### Maximum Video Resolution

1080P

### Refresh Rate

60 Hz

### Reponse Time

8ms (grey to grey)

### Colors

1.07 billion (10 bit panel)

### Contrast

10,000:1

### Brightness

250 cd/m<sup>2</sup>

### Backlight Life

LED backlit 30,000+ hours

### Viewing Angle

178° horizontal, 178° vertical

## General

### Dimension

with stand 36.69" x 8.66" x 23.81"  
without stand 36.69" x 3.46" x 21.60"

### Weight

with stand 19.27 lb  
without stand 17.68 lb

### VESA Hole Pattern

200mm x 200mm

### VESA Hole Pattern Screw Size

M5 x 12mm (top mount)  
M5 x 6mm (bottom mount)

### Stand Screw Size

ST4 x 14mm (4pcs)

### TV Menu Language

English, Spanish, French

## I/O

### HDMI x 3

HDMI #2 is with MHL and ROKU stick support

### YPbPr Component x 1

Audio plugs are shared with AV

### AV Composite x 1

Audio plugs are shared with YPbPr

### RF Antenna Input x 1

This input supports NTSC/ATSC.

QAM is not available

### PC VGA x 1

### USB 2.0 x 1

### Analog Audio In x 1

3.5mm mini-jack

### Optical Out x 1

SPDIF Digital Optical Out

### Analog Audio Out

RCA Analog Audio Out x 1  
Headphone x 1

## Power

### Power Range

100-240 VAC, 50/60 Hz 3.0 A

### Power Consumption

Avg. 61 W / Max 72 W

### Standby

≤ 1 W

## Certifications & Compliance

cTUVus

ISTA 3A

FCC Class B

Energy Star

HDMI 1.3

# Warranty

Please read this warranty card carefully, it is a “ONE-YEAR LIMITED WARRANTY” on parts and labor (90 days for commercial use) and is only valid when purchased from an Authorized Reseller, only on new and non-refurbished product, and available to customers in the Continental US, Alaska, Hawaii and Puerto Rico. See below for the oCOSMO Extended Service warranty.

## oCOSMO’s Responsibility

oCOSMO units purchased from an authorized oCOSMO U.S. Reseller in the United States and that are used in the fifty (50) United States or Puerto Rico and Canada are warranted to be free from manufacturing defects in materials and workmanship for a period of one (1) year from the date of their original retail purchase (or a period of ninety (90) days for commercial use). If the unit fails to conform to this warranty, we will service the units using new or refurbished parts. In the event that the part required for replacement is no longer in production and/or is obsolete, oCOSMO will repair or replace the unit with similar or like parts of equal value. If a similar or like part is not available, a charge may be incurred to the owner, for any upgraded parts substituted.

## Service Labor

During a period of one (1) year from the effective warranty date (or a period of ninety (90) days for commercial use), oCOSMO will provide, when needed, service labor to repair a manufacturing defect at its designated Service Center. To obtain warranty service in the United States, you must first call our Customer Support at (855) 662-6766. The determination of service will be made by oCOSMO Customer Support. PLEASE DO NOT RETURN YOUR UNIT TO oCOSMO WITHOUT PRIOR AUTHORIZATION.

## Parts

New or remanufactured parts will be used for repairs by oCOSMO at its designated Service Center for one (1) year (or ninety (90) days for commercial use) from the effective warranty date. Such replacement parts are warranted for the remaining portion of the original warranty period.

## Service

During the one (1) year (or ninety (90) days for commercial use) warranty period, oCOSMO will, at its option and sole discretion, repair or replace defective parts, including replacement of the entire Panel. The Customer will be required to ship the unit to the Service Center indicated at the time Customer Support is contacted to make the necessary repairs, you are responsible for all transportation charges to the service facility. oCOSMO is not responsible for the de-installation or re-installation of the unit.

## Packaging and Shipping Instruction

When you send the product to an authorized oCOSMO service facility you must use the original carton box and packing material or an equivalent as designated by oCOSMO. If you no longer have them please contact oCOSMO’s Customer Support.

## Not Covered

This warranty does not cover the following: cosmetic defects; damage, malfunctions, or failures resulting from shipping or transit accidents, abuse, misuse, operation contrary to furnished instructions, operation on incorrect power supplies, operation with faulty associated equipment, modification, alteration, improper servicing, tampering and or, damage from fire, water, lightning, power surges, abnormal environmental conditions, or other acts of nature; normal wear and tear (oCOSMO reserves the right to determine “wear and tear” on any and all products); unsatisfactory visual or audio performance not caused by a manufacturing defect; or displays on which the serial number has been removed or defaced. Image Sticking caused by operating at excessive brightness levels for extended periods or mishandling are not covered by this warranty. Installation, removal, transportation and reinstallation of a display and routine maintenance and cleaning, are not covered by this warranty. Any hardware, components, and/or software bundled with the display are not covered by this warranty. Any damages caused directly or indirectly by Buyer’s or Reseller’s “Value Added Feature” are not covered by this warranty or oCOSMO Inc. Any damages of any kind including, but not limited to, direct or indirect damages, lost profits, lost savings, or other special incidental, exemplary or consequential damages whether for breach of contract, tort, or otherwise, or whether arising out of the use of or inability to use the product, even if oCOSMO, INC. or

# Warranty

---

any dealer, distributor of authorized service provider/partner has been advised of the possibility of such damages, or any claim by any other warranty are not covered by this warranty or oCOSMO.

ANY IMPLIED WARRANTIES, INCLUDING ANY IMPLIED WARRANTY OF MERCHANTABILITY AND FITNESS FOR A PARTICULAR PURPOSE SHALL BE LIMITED IN DURATION TO THE PERIOD OF TIME SET FORTH ABOVE. OUR LIABILITY FOR ANY AND ALL LOSSES AND DAMAGES RESULTING FROM ANY CAUSE WHATSOEVER, INCLUDING OUR NEGLIGENCE, ALLEGED DAMAGE OR DEFECTIVE GOODS, WHETHER SUCH DEFECTS ARE DISCOVERABLE OR LATENT, SHALL IN NO EVENT EXCEED THE PURCHASE PRICE OF THE DISPLAY. WE SHALL NOT BE RESPONSIBLE FOR LOSS OF USE, COMMERCIAL LOSS OR OTHER INCIDENTAL OR CONSEQUENTIAL DAMAGES. SOME STATES DO NOT ALLOW LIMITATIONS ON HOW LONG AN IMPLIED WARRANTY LASTS OR THE EXCLUSION OR LIMITATION OF INCIDENTAL OR CONSEQUENTIAL DAMAGES, SO THE ABOVE LIMITATIONS OR EXCLUSIONS MAY NOT APPLY TO YOU. This warranty gives you specific legal rights, and you may also have other rights which vary from state to state. This is the only warranty applicable; no one is authorized to extend or modify it or to grant any other warranty.

oCOSMO retains the right to assess all warranty claims and to determine if damages are covered by the warranty. In case of a claim that is not covered by the warranty, you will be contacted to determine whether oCOSMO should repair the damage for a fee or whether the product should be returned to you as received by the repair center.

## Dead Pixel Policy

oCOSMO sets limit on the LCD at 3 dead pixels in a cluster adjacent to each other, or 5 dead pixels in a combination of color and brightness. Any number of dead or bad pixels under the limit is considered to be within normal performance specification of the LCD and is not considered defective.

## Owner's Responsibility

### Effective Warranty Date

Warranty begins on the date of sale to the end user. To ensure warranty ser-

vice, keep the dated bill or sale receipt as evidence of the purchase date. If you can no longer obtain your receipt, the warranty will revert to the unit's manufacture date according to the serial number of the unit. This limited warranty applies only to the original purchaser and is non-transferable.

## Warranty Service

For warranty service information, contact oCOSMO Technical Support at email address [ocosmoTS@ocosmo.com](mailto:ocosmoTS@ocosmo.com), via phone at (855) 662-6766, or via World Wide Web chatting service at [www.ocosmo.com](http://www.ocosmo.com). oCOSMO Technical Support is available Monday to Friday 8:30 AM to 5:30 PM Pacific Time. Parts and service labor that are oCOSMO's responsibility (see above) will be provided without charge. Other services or services not covered by the warranty are at the owner's expense. You must provide the model, serial number and date of purchase. Before you ask for warranty service, read your User Manual. You might avoid a service call.

Warranty conditions are subject to change, for latest Warranty Terms and Conditions and additional information regarding your warranty, please see complete details online at [www.ocosmo.com](http://www.ocosmo.com).

# Disclaimer



This product qualifies for ENERGY STAR in the “power saving” mode and this is the setting in which power savings will be achieved. Changing this mode under picture settings or enabling other features will increase power consumption that could exceed the limits necessary to qualify for ENERGY STAR rating. For more information on the ENERGY STAR program, please refer to [www.energystar.gov](http://www.energystar.gov).



SRS TruSurround HD is a trademark of SRS Labs, Inc. TruSurround HD technology is incorporated under license from SRS Labs, Inc.



HDMI, the HDMI logo and High-Definition Multimedia Interface are trademarks or registered trademarks of HDMI Licensing LLC.



MHL and the MHL logo are a trademark, registered trademark or service mark of MHL, LLC in the United States and /or other countries.

# Disclaimer

---

Roku™ and the Roku logo are registered trademarks of Roku Inc. in the United States and other countries.

oCOSMO is a trademark or registered trademark of oCOSMO Group.

oCOSMO, Inc. shall not be liable for technical or editorial errors or omissions contained herein; nor for incidental or consequential damages resulting from furnishing this material, or the performance or use of this product.

In the interest of continuing product improvement, oCOSMO, Inc. reserves the right to change product specifications without notice. Information in this document may change without notice.

No part of this document may be copied, reproduced, or transmitted by any means, for any purpose without prior written permission from oCOSMO Inc.

# Compliance

## FCC Compliance Statement

This device complies with Part 15 of the FCC Rules.

Operation is subject to the following conditions:

This device may not cause harmful interference

This device must accept any interference received, including interference that may cause undesired operation.

Please Note: This equipment has been tested and found to comply with the limits for a Class B digital device, pursuant to part 15 of the FCC Rules. These limits are designed to provide reasonable protection against harmful interference in a residential installation. This equipment generates and can radiate radio frequency energy and, if not installed and used in accordance with the instructions, may cause harmful interference to radio communications. However, there is no guarantee that interference will not occur in a particular installation. If this equipment does cause harmful interference to radio or television reception, which can be determined by turning the equipment off and on, the user is encouraged to try to correct the interference by one or more of the following measures:

- Reorient or relocate the receiving antenna.
- Increase the separation between the equipment and the receiver.
- Connect the equipment into an outlet on a circuit different from that to which the receiver is connected.

Caution: To comply with the limits for an FCC Class B computing device, always use the signal cord and power cord supplied with this unit.

The Federal communications Commission warns that changes or modifications to the unit not expressly approved by the party responsible for compliance could void the user's authority to operate the equipment.

## European Notice

Products with the CE marking comply with both the EMC Directive (89/336/EEC), (93/68/EEC) and the Low Voltage Directive (72/23/EEC) issued by the Commission of the European Community.